



LABORATORY FURNACES



Facts

- Production of Arts & Crafts furnaces, laboratory furnaces, dental furnaces and industrial furnaces since 1947
- Production site in Lilienthal/Bremen - Made in Germany
- 600 employees worldwide
- 150,000 customers in more than 100 countries
- Very wide product range of furnaces
- One of the biggest R&D departments in the furnace industry
- High vertical integration

Global Sales and Service Network

- Manufacturing only in Germany
- Decentralized sales and service close to the customer
- Own sales organization and long term sales partners in all important world markets
- Individual on-site customer service and consultation
- Fast remote maintenance options for complex furnaces
- Reference customers with similar furnaces or systems close to you
- Secured spare parts supply, many spare parts available from stock
- Further information see page 90

Setting Standards in Quality and Reliability

- Project planning and construction of tailor-made thermal process plants incl. material handling and charging systems
- Innovative controls and automation technology, adapted to customer needs
- Very reliable and durable furnace systems
- Customer test center for process assurance

Experience in Thermal Processing

- Thermal Process Technology
- Additive Manufacturing
- Advanced Materials
- Fiber Optics/Glass
- Foundry
- Laboratory
- Dental
- Arts & Crafts

Table of Contents



Muffle Furnaces up to 1400 °C

Muffle furnaces up to 1200 °C	6
Economy muffle furnaces up to 1100 °C	8
Muffle furnaces with brick insulation up to 1300 °C	9
Muffle furnaces up to 1400 °C	10
Muffle furnaces with embedded heating elements up to 1100 °C	11
Ashing furnaces up to 1100 °C	12
Ashing furnaces with integrated exhaust gas cleaning up to 1100 °C	14
Weighing furnaces up to 1200 °C	15
Exhaust systems/accessories for muffle furnaces	16

Tube Furnaces up to 1800 °C

Compact tube furnaces up to 1300 °C	20
Split-type tube furnaces for horizontal or vertical operation up to 1300 °C	22
Rotary tube furnaces for batch operation up to 1100 °C	24
Rotary hearth furnaces for processes with continuous movement up to 1300 °C	26
Tube furnaces with stand for horizontal and vertical operation up to 1500 °C	28
High-temperature tube furnaces with SiC rod heating up to 1600 °C	29
High-temperature tube furnaces for horizontal or vertical operation up to 1800 °C	30
Working tubes	32
Gas supply systems/vacuum operation	34
Control alternatives for tube furnaces	38
Customized tube furnaces	39

Ovens and Forced Convection Furnaces up to 850 °C

Ovens up to 300 °C	42
Chamber ovens up to 260 °C	44
Forced convection chamber furnaces – tabletop design	46
Forced convection chamber furnaces up to 675 liter	48
Forced convection chamber furnaces – tabletop design	50
Forced convection chamber furnaces up to 500 liter with safety technology	51

Chamber Furnaces up to 1400 °C

Chamber furnaces up to 1400 °C	54
Chamber furnaces up to 1280 °C	56
Accessories for the heat treatment of metals	57

High-Temperature Furnaces up to 1800 °C

High-temperature furnaces MoSi ₂ heating elements table-top model up to 1800 °C	60
High-temperature furnaces with SiC rod heating table-top model up to 1600 °C	62
High-temperature bottom loading furnaces up to 1650 °C	63
High-temperature furnaces with scale up to 1750 °C	64
Combi high-temperature furnace up to 1750 °C with integrated catalytic post combustion	65
High-temperature furnaces MoSi ₂ heating elements floor-standing model up to 1800 °C	66
High-temperature furnaces with SiC rod heating floor-standing model up to 1550 °C	68
High-temperature furnaces with MoSi ₂ heating elements with refractory brick insulation up to 1700 °C	69

Furnaces for Special Applications

Fire assay/cupellation furnaces up to 1300 °C	72
Gradient or lab strand annealing furnaces up to 1300 °C	74
Fast-firing furnaces up to 1300 °C	75
Laboratory melting furnaces up to 1400 °C	76

Process Control and Documentation

Temperature uniformity and system accuracy	77
Nabertherm controller series 500	80
MyNabertherm app for mobile monitoring of process progress	82
Functions of the standard controllers	84
Process data storage and data input via PC	85
PLC controls - HiProSystems	87
Process data storage	88
Nabertherm control center NCC	89

Muffle Furnaces up to 1400 °C

Muffle furnaces are the reliable and long-lasting all-rounders in the laboratory and are ideally suited for a large number of processes in the field of material research and heat treatment. Moreover, Nabertherm offers specially designed ashing furnaces for the wide range of analyzes of ash residues.

The following equipment applies to all furnaces in this chapter:



Dual shell ventilated housing made of textured stainless steel sheets for low surface temperature and high stability



Solid state relays provide for lownoise operation



Exclusive use of insulation materials without categorization according to EC Regulation No 1272/2008 (CLP). This explicitly means that alumino silicate wool, also known as “refractory ceramic fiber” (RCF), which is classified and possibly carcinogenic, is not used.



Defined application within the constraints of the operating instructions



Controller with intuitive touch operation



NTLog Basic for Nabertherm controller: recording of process data with USB-flash drive



Freeware NTEdit for convenient program input via Excel™ for Windows™ on the PC



Freeware NTGraph for evaluation and documentation of firings using Excel™ for Windows™ on the PC



MyNabertherm App for online monitoring of the firing on mobile devices for free download



As additional equipment: Process control and documentation via VCD software package for monitoring, documentation and control



Furnace Group	Model	Page
Muffle furnaces up to 1100 °C or 1200 °C	L(T)	6
Economy muffle furnaces up to 1100 °C	LE	8
Muffle furnaces with brick insulation up to 1300 °C	L(T) .. 13	9
Muffle furnaces up to 1400 °C	L(T) .. 14	10
Muffle furnaces with embedded heating elements in the ceramic muffle up to 1100 °C	L(T) .. SKM	11
Ashing furnaces up to 1100 °C	LV(T)	12
Ashing furnaces up to 1100 °C with integrated exhaust gas cleaning	L .. BO	14
Weighing furnaces up to 1200 °C	L(T) .. SW	15
Exhaust systems/accessories for muffle furnaces		16

Muffle Furnaces up to 1100 °C or 1200 °C

The muffle furnaces L 3/11 - LT 60/12 have been proven for daily laboratory use. These models stand out for their excellent workmanship, advanced and attractive design, and high level of reliability. The muffle furnaces come equipped with either a flap door or lift door at no extra charge.



Muffle furnace LT 5/12 with lift door

Standard Equipment

- Tmax 1100 °C or 1200 °C
- Heating from two sides by ceramic heating plates (heating from three sides for muffle furnaces L 24/11 - LT 60/12) for an optimal temperature uniformity
- Thermocouple type N (1100 °C) or type S (1200 °C)
- Ceramic heating plates with integral heating element which is safeguarded and easy to replace
- Optional flap door (L) which can be used as work platform or lift door (LT) with hot surface facing away from the operator
- Adjustable air inlet integrated in door (see illustration)
- Exhaust air outlet in rear wall of furnace
- Controller with touch operation B510 (5 programs with each 4 segments) resp. controller R7 for L 1/12 (adjustable for one temperature), alternative controllers see page 84



Muffle furnace L 3/11 with flap door

Additional Equipment

- Chimney, chimney with fan or catalytic converter (not for L 1 and L 15) see page 16
- Over-temperature limiter with adjustable cutout temperature as temperature limiter to protect the furnace and load
- Protective gas connection to purge with non-flammable process gases (not available in combination with chimney, chimney with fan or catalytic converter) not gas tight
- Manual or automatic gas supply system
- Port for thermocouple in the rear wall or in the furnace door
- Charging rack with closed or perforated trays for loading the furnace in two levels incl. holder for inserting/removing the trays up to a max. temperature of 800 °C and a max. loading weight per layer of 2 kg for the L(T) 9/11 respectively 3 kg for the L(T) 15/11 see page 13
- Please see page 17 for more accessories



Muffle furnace L 3/12



Muffle furnace L 3/11 with flap door

Model	Tmax in °C ¹	Inner dimensions in mm			Volume in l	Outer dimensions ² in mm			Temperature uniformity of +/- 5K in the empty workspace ⁵			Max. connected load in kW	Electrical connection*	Weight in kg	Heating time in min ⁴
		w	d	h		W	D	H ³	w	d	h				
L(T) 3/11	1100	160	140	100	3	385	330	405+155	110	50	50	1.3	1-phase	21	41
L(T) 5/11	1100	205	170	130	5	385	390	460+205	170	80	80	2.6	1-phase	27	47
L(T) 9/11	1100	235	240	170	9	415	455	515+240	180	150	120	3.3	1-phase	35	63
L(T) 15/11	1100	230	340	170	15	415	555	515+240	180	250	120	3.5	1-phase	43	74
L(T) 24/11	1100	280	340	250	24	490	555	580+320	230	250	200	4.9	3-phase	52	69
L(T) 40/11	1100	320	490	250	40	530	705	580+320	270	400	200	6.5	3-phase	70	80
LT 60/11	1100	380	490	330	60	610	705	660+385	290	360	240	9.8	3-phase	83	150
L 1/12	1200	90	115	110	1	290	280	410	40	45	60	1.6	1-phase	15	25
L(T) 3/12	1200	160	140	100	3	385	330	405+155	110	50	50	1.3	1-phase	21	48
L(T) 5/12	1200	205	170	130	5	385	390	460+205	170	80	80	2.6	1-phase	27	59
L(T) 9/12	1200	235	240	170	9	415	455	515+240	180	150	120	3.3	1-phase	35	78
L(T) 15/12	1200	230	340	170	15	415	555	515+240	180	250	120	3.5	1-phase	43	99
L(T) 24/12	1200	280	340	250	24	490	555	580+320	230	250	200	4.9	3-phase	52	82
L(T) 40/12	1200	320	490	250	40	530	705	580+320	270	400	200	6.5	3-phase	70	97
LT 60/12	1200	380	490	330	60	610	705	660+385	290	360	240	9.8	3-phase	83	160

¹Recommended working temperature for processes with longer dwell times is 1000 °C (L../11) resp. 1100 °C (L../12)

²External dimensions vary when furnace is equipped with additional equipment. Dimensions on request.

³Including opened lift door (LT models)

⁴Heating time of the empty and closed furnace up to Tmax - 100 K (connected to 230 V 1/N/PE resp. 400 V 3/N/PE)

⁵Temperature uniformity of +/- 5 K with closed fresh-air inlet in empty work space according to DIN 17052-1 at working temperatures above 800 °C see page 77

*Please see page 84 for more information about supply voltage



Chimney with fan



Adjustable air inlet integrated in the door



Gas supply system for non-flammable process gas

Economy Muffle Furnaces up to 1100 °C

With their convincing price/performance ratio and the fast heat-up rates, these compact muffle furnaces are perfect for many applications in the laboratory. Quality features like the dual shell furnace housing of rust-free stainless steel, their compact, lightweight constructions, or the heating elements encased in quartz glass tubes make these models reliable partners for your application.



Muffle furnace LE 6/11

Standard Equipment

- Tmax 1100 °C
- Heating from two sides from heating elements protected in quartz glass tubes
- Fast heating times (see table)
- Maintenance-friendly replacement of heating elements and insulation
- Housing coated in RAL 9003
- Flap door which can also be used as a work platform
- Exhaust air outlet in rear wall
- Compact dimensions and light weight
- Controller mounted under the door to save space
- Controller R7 (adjustable for one temperature), controls description see page 84

Additional Equipment

- Chimney, chimney with fan or catalytic converter (not for LE 1 and LE 2) see page 16
- Please see page 17 for more accessories

Model	Tmax in °C ¹	Inner dimensions in mm			Volume in l	Outer dimensions ² in mm			Temperature uniformity of +/- 5K in the empty work- space ⁴			Max. connected load in kW	Electrical connection*	Weight in kg	Heating time in min ³
		w	d	h		W	D	H	w	d	h				
LE 1/11	1100	90	115	110	1	290	280	410	40	65	60	1.6	1-phase	15	10
LE 2/11	1100	110	180	110	2	330	390	410	60	130	60	1.9	1-phase	20	15
LE 6/11	1100	170	200	170	6	390	440	470	120	150	120	2.0	1-phase	27	30
LE 14/11	1100	220	300	220	14	440	540	520	170	250	170	3.2	1-phase	35	35
LE 24/11	1100	260	330	280	24	490	570	590	200	270	230	3.5	1-phase	42	40

¹Recommended working temperature for processes with longer dwell times is 1050 °C

²External dimensions vary when furnace is equipped with additional equipment. Dimensions on request.

³Heating time of the empty and closed furnace up to Tmax -100 K (connected to 230 V 1/N/PE)

⁴Temperature uniformity of +/- 5 K with closed fresh-air inlet in empty work space according to DIN 17052-1 at working temperatures above 800 °C see page 77

*Please see page 84 for more information about supply voltage



Muffle furnace LE 1/11



Muffle furnace LE 14/11



Heating elements protected in quartz glass tubes

Muffle Furnaces with Brick Insulation up to 1300 °C

Heating elements on support tubes radiating freely into the furnace chamber provide for particularly short heating times for these muffle furnaces. Thanks to their robust lightweight refractory brick insulation, they can reach a maximum working temperature of 1300 °C. These muffle furnaces thus represent an interesting alternative to the familiar L(T) .. /12 models, when you need a higher application temperature.



Muffle furnace L 9/13 with flap door

Standard Equipment

- Tmax 1300 °C
- Heating from two sides
- Heating elements on support tubes ensure free heat radiation and a long service life
- Multi-layer insulation with robust lightweight refractory bricks in the furnace chamber
- Optional flap door (L) which can be used as work platform or lift door (LT) with hot surface facing away from the operator
- Adjustable air inlet in the furnace door
- Exhaust air outlet in rear wall of furnace
- Controller with touch operation B510 (5 programs with each 4 segments), alternative controllers see page 84

Additional Equipment

- Chimney, chimney with fan or catalytic converter see page 16
- Over-temperature limiter with adjustable cutout temperature as temperature limiter to protect the furnace and load
- Protective gas connection to purge with non-flammable process gases (not available in combination with chimney, chimney with fan or catalytic converter) not gas tight
- Manual or automatic gas supply system
- Port for thermocouple in the rear wall or in the furnace door
- Please see page 17 for more accessories

Model	Tmax in °C ¹	Inner dimensions in mm			Volume in l	Outer dimensions ² in mm			Temperature uniformity of +/- 5K in the empty workspace ⁵			Max. connected load in kW	Electrical connection*	Weight in kg	Heating time in min ⁴
		w	d	h		W	D	H ³	w	d	h				
L, LT 5/13	1300	225	170	130	5	490	450	580+320	170	100	80	2.6	1-phase	46	55
L, LT 9/13	1300	250	240	170	9	530	525	630+350	180	170	120	3.3	1-phase	58	60
L, LT 15/13	1300	250	340	170	15	530	625	630+350	180	270	120	3.5	1-phase	71	80

¹Recommended working temperature for processes with longer dwell times is 1200 °C

*Please see page 84 for more information about supply voltage

²External dimensions vary when furnace is equipped with additional equipment. Dimensions on request.

³Including opened lift door (LT models)

⁴Heating time of the empty and closed furnace up to Tmax - 100 K (connected to 230 V 1/N/PE)

⁵Temperature uniformity of +/- 5 K with closed fresh-air inlet in empty work space according to DIN 17052-1 at working temperatures above 800 °C see page 77



Muffle furnace LT 5/13 with lift door



Furnace lining with high-quality lightweight refractory brick insulation



Example of an over-temperature limiter

Muffle Furnaces up to 1400 °C

These models stand out for their excellent workmanship, advanced and attractive design, and high level of reliability. Heating elements on support tubes radiating freely into the furnace chamber provide for particularly short heating times and a maximum temperature of 1400 °C. These muffle furnaces are a good alternative to the familiar L(T) .. /12 series when higher application temperatures are needed.



Muffle furnace LT 9/14 with lift door

Standard Equipment

- Tmax 1400 °C
- Heating from two sides
- Heating elements on support tubes ensure free heat radiation and a long service life
- Adjustable air inlet integrated in door
- Exhaust air outlet in rear wall of furnace
- Controller with touch operation B510 (5 programs with each 4 segments), alternative controllers see page 84

Additional Equipment

- Chimney, chimney with fan or catalytic converter see page 16
- Over-temperature limiter with adjustable cutout temperature as temperature limiter to protect the furnace and load
- Protective gas connection to purge with non-flammable process gases (not available in combination with chimney, chimney with fan or catalytic converter), not gas tight
- Manual or automatic gas supply system
- Please see page 17 for more accessories

Model	Tmax in °C ¹	Inner dimensions in mm			Volume in l	Outer dimensions ² in mm			Temperature uniformity of +/- 5K in the empty workspace ⁵			Max. connected load in kW	Electrical connection*	Weight in kg	Heating time in min ⁴
		w	d	h		W	D	H ³	w	d	h				
L, LT 5/14	1400	225	175	130	5	490	450	580+320	170	120	80	2.6	1-phase	42	45
L, LT 9/14	1400	250	250	170	9	530	525	630+350	180	190	120	3.5	1-phase	55	50
L, LT 15/14	1400	250	350	170	15	530	625	630+350	180	290	120	3.5	1-phase	63	70

¹Recommended working temperature for processes with longer dwell times is 1300 °C

²External dimensions vary when furnace is equipped with additional equipment. Dimensions on request.

³Including opened lift door

⁴Heating time of the empty and closed furnace up to Tmax -100 K (connected to 230 V 1/N/PE)

⁵Temperature uniformity of +/- 5 K with closed fresh-air inlet in empty work space according to DIN 17052-1 at working temperatures above 800 °C see page 77

*Please see page 84 for more information about supply voltage



Muffle furnace L 9/14 with flap door



Chimney with fan



Example of an over-temperature limiter

Muffle Furnaces with Embedded Heating Elements in the Ceramic Muffle up to 1100 °C

We particularly recommend the muffle furnace L 9/11/SKM for heat treatment of aggressive substances. The furnace has a ceramic muffle with embedded heating from four sides. The muffle furnace thus combines a very good temperature uniformity with excellent protection of the heating elements from aggressive atmospheres. Another aspect is the smooth, nearly particle free muffle (furnace door made of fiber insulation), an important quality feature.



Muffle furnace L 9/11/SKM with flap door

Standard Equipment

- Tmax 1100 °C
- Muffle heated from four sides
- Furnace chamber with embedded ceramic muffle, high resistance to aggressive gasses and vapours
- Optional flap door (L) which can be used as work platform or lift door (LT) with hot surface facing away from the operator
- Adjustable working air inlet in the door
- Exhaust air outlet in rear wall of furnace
- Controller with touch operation B510 (5 programs with each 4 segments), alternative controllers see page 84

Additional Equipment

- Chimney, chimney with fan or catalytic converter see page 16
- Over-temperature limiter with adjustable cutout temperature as temperature limiter to protect the furnace and load
- Protective gas connection to purge with non-flammable process gases (not available in combination with chimney, chimney with fan or catalytic converter) not gas tight
- Manual or automation gas supply system
- Port for thermocouple in the rear wall or in the furnace door
- Please see page 17 for more accessories

Modell	Tmax in °C ¹	Inner dimensions in mm			Volume in l	Outer dimensions ² in mm			Max. connected load in kW	Electrical connection*	Weight in kg	Heating time in min ⁴
		w	d	h		W	D	H				
L 9/11/SKM	1100	230	240	170	9	490	505	580	3.7	1-phase	50	75
LT 9/11/SKM	1100	230	240	170	9	490	505	580+320 ³	3.7	1-phase	50	75

¹Recommended working temperature for processes with longer dwell times is 1000 °C

²External dimensions vary when furnace is equipped with additional equipment. Dimensions on request.

³Including opened lift door

⁴Heating time of the empty and closed furnace up to Tmax -100 K (connected to 230 V 1/N/PE)

*Please see page 84 for more information about supply voltage



Muffle furnace L 9/11/SKM



Gas supply system for non-flammable process gas



Muffle heated from four sides

Ashing Furnaces up to 1100 °C

Ashing furnace LV(T) .. 11 is designed especially for ashing processes to 1050 °C in the laboratory. Applications include determining loss on ignition, ashing food and plastics for subsequent substance analysis. A special fresh-air and exhaust air system ensures that the air is replaced 6 times per minute so that there is always sufficient oxygen for the ashing process. Incoming air passes the furnace heating and is pre-heated to ensure good temperature uniformity.



Ashing furnace LV 5/11

Standard Equipment

- Tmax 1100 °C
- Heating from two sides
- Ceramic heating plates with integral heating element which is safeguarded, and easy to replace
- Air exchange of more than 6 times per minute
- Good temperature uniformity due to preheating of incoming air, temperature uniformity according to DIN 17052-1 to +/- 10 °C in the defined empty work area (from 550 °C) see page 73
- Suitable for many standardized ashing processes according to ISO, ASTM, EN, and DIN
- Optional flap door (LV) which can be used as work platform or lift door (LVT) with hot surface facing away from the operator
- Controller with touch operation B510 (5 programs with each 4 segments), alternative controllers see page 84



Ashing furnace LVT 9/11

Additional Equipment

- Over-temperature limiter with adjustable cutout temperature as temperature limiter to protect the furnace and load
- Port for thermocouple in the rear wall or in the furnace door
- Charging rack with closed or perforated trays for loading the furnace in two levels incl. holder for inserting/removing the trays up to a max. temperature of 800 °C and a max. loading weight per layer of 2 kg for the L(T) 9/11 respectively 3 kg for the LV(T) 15/11 see page 13
- Please see page 17 for more accessories

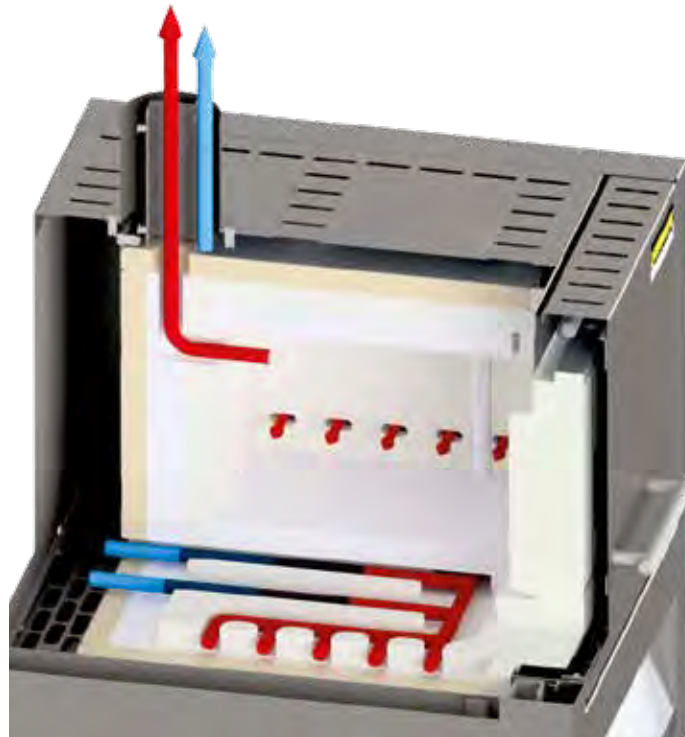

— Hot air
— Cold air

Air inlet and exhaust flow principle in ashing furnaces

Model	Tmax	Inner dimensions in mm			Volume	Outer dimensions ² in mm			Max. weight of hydrocarbons	Max. evaporation rate	Max. connected load in kW	Electrical connection*	Weight	Heating time
		in °C ¹	w	d		h	in l	W						
Flap door														
LV 3/11	1100	180	150	120	3	345	390	810	5	0.1	1.3	1-phase	20	45
LV 5/11	1100	205	170	130	5	385	415	810	10	0.2	2.6	1-phase	29	55
LV 9/11	1100	235	240	170	9	415	485	865	15	0.3	3.3	1-phase	36	70
LV 15/11	1100	230	340	170	15	415	590	865	25	0.3	3.6	1-phase	44	80

Model	Tmax	Inner dimensions in mm			Volume	Outer dimensions ² in mm			Max. weight of hydrocarbons	Max. evaporation rate	Max. connected load in kW	Electrical connection*	Weight	Heating time
		in °C ¹	w	d		h	in l	W						
Lift door														
LVT 3/11	1100	180	150	120	3	345	390	810	5	0.1	1.3	1-phase	20	45
LVT 5/11	1100	205	170	130	5	385	415	810	10	0.2	2.6	1-phase	29	55
LVT 9/11	1100	235	240	170	9	415	485	865	15	0.3	3.3	1-phase	36	70
LVT 15/11	1100	230	340	170	15	415	590	865	25	0.3	3.6	1-phase	44	80

¹Recommended working temperature for processes with longer dwell times is 1000 °C

*Please see page 84 for more information about supply voltage

²External dimensions vary when furnace is equipped with additional equipment. Dimensions on request.

³Including exhaust tube (Ø 80 mm)

⁴Approx. heating time of the empty and closed furnace up to Tmax -100 K (connected to 230 V 1/N/PE)

Charging rack for model	Article No.	Tmax	Outer dimensions in mm			Number of levels	Dimensions shelf (level 1) in mm			Max. weight per level
			in °C	W	D		H	W	D	
LV(T) 9/11	6000079693	800	215	218,5	95	2	202	202	47	2
LV(T) 15/11	6000078459	800	215	318,5	95	2	202	302	47	3

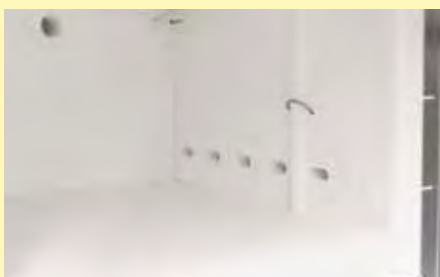

Furnace chamber with air inlet openings for air exchange of more than 6 times per minute



Ashing furnace LV 5/11 with port for thermocouple in the rear wall of furnace

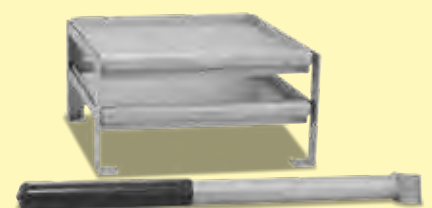

Charging rack to load the furnace in different levels

Ashing Furnaces with Integrated Exhaust Gas Cleaning up to 1100 °C

The ashing furnaces L ../11 BO are specially designed for processes in which organic substances have to be evaporated from the charge, as e. g. during debinding of small ceramic products after additive manufacturing. Other processes, for which this furnace series is designed for, are for example, ashing of (food) samples, thermal cleaning of injection molding tools or loss on ignition determination.

The ashing furnaces therefore have a passive safety system and integrated exhaust gas post combustion. An exhaust gas fan extracts the exhaust gases from the furnace and simultaneously supplies fresh air to the furnace atmosphere with the result that sufficient oxygen is always available for the process. The incoming air is guided behind the furnace heating and preheated to ensure good temperature uniformity. Exhaust gases are directly led from the furnace chamber to the integrated post combustion system, where they are burned and catalytically cleaned. After the debinding/ashing process (up to max. 600 °C), a sintering process up to max. 1100 °C can be performed.



Ashing furnace L 40/11 BO

Standard Equipment

- Tmax 600 °C for the incineration process
- Tmax 1100 °C for the subsequent process
- Three-side heating (both sides and bottom)
- Ceramic heating plates with embedded heating wire
- Steel collecting pan protects the bottom insulation
- Spring-assisted closing of the furnace door (flap door) with mechanical locking against unintentional opening
- Thermal/catalytic post combustion, integrated in the exhaust channel, up to 600 °C in function
- Temperature control of post combustion can be set up to 850 °C
- Monitored exhaust air
- Inlet-air preheated through the bottom heating plate
- Over-temperature limiter with adjustable cutout temperature as temperature limiter to protect the furnace and load
- Controller with touch operation C550 (10 programs with each 20 segments), alternative controllers see page 84

Model	Tmax in °C ¹	Inner dimensions in mm			Volume in l	Outer dimensions ² in mm			Max. loading weight of organic substances in g	Max. evaporation rate of organic substances g/min	Connected load in kW	Electrical connection*	Weight in kg
		w	d	h		W	D	H ³					
L 9/11 BO	1100	230	240	170	9	415	575	750	75	1.0	7.0	3-phase	60
L 24/11 BO	1100	280	340	250	24	490	675	800	150	2.0	9.0	3-phase	90
L 40/11 BO	1100	320	490	250	40	530	825	800	200	2.1	11.5	3-phase	110

¹Recommended working temperature for processes with longer dwell times is 1000 °C

²External dimensions vary when furnace is equipped with additional equipment. Dimensions on request.

³Including exhaust tube (Ø 80 mm)

*Please see page 84 for more information about supply voltage



Ashing furnace L 9/11 BO



Steel collecting pan protects the bottom insulation



■ Hot air
■ Cold air

Schematic presentation of air circulation in ashing furnace L 24/11 BO

Muffle Furnace incl. Scale and Software for Determination of Combustion Loss

This weighing furnace with integrated precision scale and software, was designed especially for combustion loss determination in the laboratory. The determination of combustion loss is necessary, for instance, when analyzing sludges and household garbage, and is also used in a variety of other processes for the evaluation of results. The difference between the charged total mass and the combustion residue is the combustion loss. During the process, the software included records both the temperature and the weight loss.

Standard Equipment

Like muffle furnaces L(T), except:

- Delivery includes base, ceramic plunger with base plate in the furnace lining, precision scale and software package
- 4 scales available for different maximum weights and scaling ranges
- Process control and documentation for temperature and combustion loss via VCD software package for monitoring, documentation and control see page 86
- Controller with touch operation B510 (5 programs with each 4 segments), alternative controllers see page 84

Additional Equipment

- Chimney, chimney with fan or catalytic converter
- Over-temperature limiter with adjustable cutout temperature as temperature limiter to protect the furnace and load
- Port for thermocouple in the rear wall or in the furnace door
- Please see page 26 for more accessories



Weighing furnace L 9/11/SW with flap door

Model	Tmax in °C ¹	Inner dimensions in mm			Volume in l	Outer dimensions ² in mm			Max. connected load in kW	Electrical connection*	Weight in kg	Heating time in min ⁴
		w	d	h		W	D	H				
L(T) 9/11/SW	1100	230	240	170	9	415	455	740+240 ³	3.3	1-phase	50	65
L(T) 9/12/SW	1200	230	240	170	9	415	455	740+240 ³	3.3	1-phase	50	75

¹Recommended working temperature for processes with longer dwell times is 1000 °C (L 9/11) resp. 1100 °C (L 9/12)

*Please see page 84 for more information about supply voltage

²External dimensions vary when furnace is equipped with additional equipment. Dimensions on request.

³Including opened lift door (Model LT ..)

⁴Heating time of the empty and closed furnace up to Tmax -100 K (connected to 230 V 1/N/PE)

Scale type	Readability in g	Maximum weighing range in g	Weight of plunger in g	Calibration value in g	Minimum load in g
EW-2200	0.01	2200 incl. plunger	850	0.1	0.5
EW-4200	0.01	4200 incl. plunger	850	0.1	0.5
EW-6200	0.01	6200 incl. plunger	850	-	1.0
EW-12000	0.10	12000 incl. plunger	850	1.0	5.0



4 scales available for different maximum weights and scaling ranges



Example of an over-temperature limiter

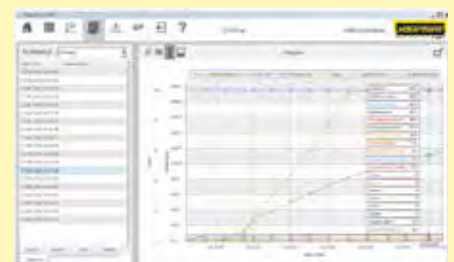

Graphic display of process curve

Exhaust Systems/Accessories



Article No.: 631000140

Exhaust Vent

Exhaust vent for collection and upstream direction of escaping gases



Article No.: 6000140311

Chimney with Fan

Exhaust gases are better removed from the furnace and discharged. The B500 - P580 controllers can be used to switch the chimney with fan automatically (not for models L(T) 15.., L 1/12, LE 1/11, LE 2/11).*



Article No.: 631000166

Catalytic Converter with Fan

Organic components are catalytically cleaned at about 600 °C, broken into carbon dioxide and water vapour. Irritating odors are thus largely eliminated. The B500 - P580 controllers can be used to switch the catalytic converter automatically (not for models L(T) 9/14, L(T) 15.., L 1/12, LE 1/11, LE 2/11).*

* Note: If other controller types are used an adapter cable for connection to mains supply has to be ordered separately. The device will be activated by plugging in the socket.

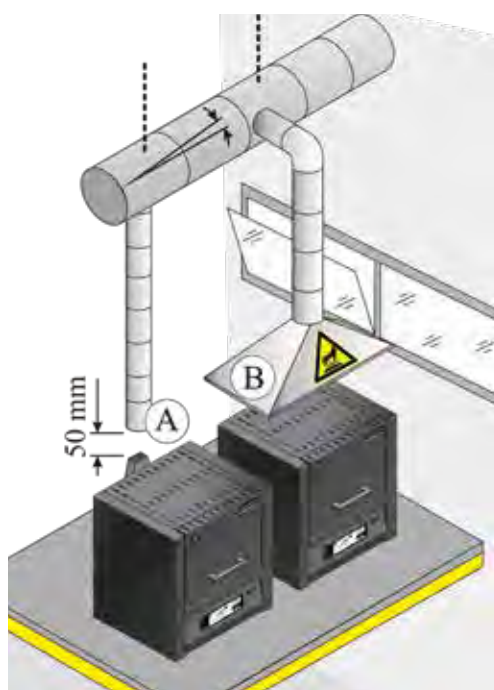

Various ways of removing the exhaust air

Exhaust Air Extraction

When exhaust gases are generated during the process it is mandatory to guide them outside in an adequate way. The relevant operating instructions must be always taken into consideration. When exhaust gas pipings are installed it is always necessary that a local ventilation technician lays out the system in accordance to the real environment.

There are different possibilities to guide the exhaust gases out. In many cases the furnace is positioned under a laboratory extraction provided by the customer (B). In these cases the use of an exhaust vent is recommended just to guide the gases upwards.

For this purpose metal exhaust gas pipes with NW 80 to NW 120 (A) can be used. They must be installed continuously rising and fastened to the wall or ceiling. Center the pipe over the furnace vent (for models with vent fan or catalytic converter, NW 120 is necessary). The exhaust gas pipe must not be installed with a tight fit to the furnace vent pipe since this would prevent any bypass effect. This is necessary so that not too much fresh air is sucked in by the furnace.



Article No.:
699000279: saggars
110 x 75 x 30 mm
699000985: lid
110 x 75 x 5 mm

Square Saggars for Furnaces LHTC and LHT, Tmax 1600 °C

The load is placed in ceramic saggars for optimal utilization of the furnace space. Up to three saggars can be stacked on top of each other in the furnace. In models LHT 01/17 D and LHTCT 01/16 up to two saggars can be stacked. Each saggars has cut-outs for better ventilation. The top saggars should be closed with a lid made of ceramic.



Article No.:
699001054: sintering dish
Ø 115 x 15 mm
699001055: spacer ring
Ø 115 x 20 mm

Round Saggars (Ø 115 mm) for Furnaces LHT/LB, Tmax 1650 °C

These saggars are perfectly suited for furnaces LHT/LB. The load is placed in the saggars. Up to three saggars can be stacked on top of each other in order to use the overall furnace chamber.

Select between different bottom plates and collecting pans for protection of the furnace and easy loading (for models L, LT, LE, LV and LVT on pages 6 - 15). Steel collecting pans may deform/distort under heat. For batches that are sensitive to tipping, ceramic shelves to protect the furnace bottom are recommended..



Ceramic Ribbed Plate, Tmax 1200 °C



Ceramic Collecting Pan, Tmax 1300 °C



Stainless Steel Collecting Pan, Tmax 1100 °C

For models	Ceramic ribbed plate		Ceramic collecting pan		Stainless steel collecting pan (Material 1.4828)	
	Articel No.	Dimensions in mm	Articel No.	Dimensions in mm	Articel No.	Dimensions in mm
L 1, LE 1	691601835	110 x 90 x 12.7	-	-	691404623	85 x 100 x 20
LE 2	691601097	170 x 110 x 12.7	691601099	100 x 160 x 10	691402096	100 x 180 x 20
L 3, LT 3, LV 3, LVT 3	691600507	150 x 140 x 12.7	691600510	150 x 140 x 20	691400145	150 x 140 x 20
L 5, LT 5, LV 5, LVT 5	691600508	190 x 170 x 12,7	691600511	190 x 170 x 20	691400146	190 x 170 x 20
LE 6	691600508	190 x 170 x 12,7	691600511	190 x 170 x 20	6000095954	160 x 200 x 20
L 9, LT 9, LV 9, LVT 9, N 7	691600509	240 x 220 x 12.7	691600512	240 x 220 x 20	691400147	240 x 220 x 20
LE 14	691601098	210 x 290 x 12.7	-	-	691402097	210 x 290 x 20
L 15, LT 15, LV 15, LVT 15, N 11	691600506	340 x 220 x 12.7	-	-	691400149	220 x 340 x 20
L 24, LT 24	691600874	340 x 270 x 12.7	-	-	691400626	270 x 340 x 20
L 40, LT 40	691600875	490 x 310 x 12.7	-	-	691400627	310 x 490 x 20



Article No.:
493000004

Gloves, Tmax 650 °C

For protection of the operator when loading or removing hot materials



Article No.:
491041101

Gloves, Tmax 700 °C

For protection of the operator when loading or removing hot materials



Article No.:
493000002 (300 mm)
493000003 (500 mm)

Charing Tongs

For easy loading and unloading of the furnace

Tube Furnaces up to 1800 °C

Tube furnaces are ideal for heat treating small components and can be perfectly adapted to the different processes by using an extensive range of accessories. Particularly due to the different gas supply systems, tube furnaces are ideal for processes in a defined atmosphere with flammable or non-flammable process gases or under vacuum and are characterized by excellent temperature uniformity.

The following equipment applies to all furnaces in this chapter:



Dual shell ventilated housing made of textured stainless steel sheets for low surface temperature and high stability



Solid state relays provide for lownoise operation



Exclusive use of insulation materials without categorization according to EC Regulation No 1272/2008 (CLP). This explicitly means that alumino silicate wool, also known as “refractory ceramic fiber” (RCF), which is classified and possibly carcinogenic, is not used.



Defined application within the constraints of the operating instructions



Controller with intuitive touch operation



NTLog Basic for Nabertherm controller: recording of process data with USB-flash drive



Freeware NTEdit for convenient program input via Excel™ for Windows™ on the PC



Freeware NTGraph for evaluation and documentation of firings using Excel™ for Windows™ on the PC



MyNabertherm App for online monitoring of the firing on mobile devices for free download



As additional equipment: Process control and documentation via VCD software package for monitoring, documentation and control



Furnace Group	Model	Page
Compact tube furnaces up to 1300 °C	RD, R	20
Split-type tube furnaces for horizontal or vertical operation up to 1300 °C	RSH, RSV	22
Rotary tube furnaces for batch operation up to 1100 °C	RSRB	24
Rotary tube furnaces for processes with continuous movement up to 1300 °C	RSRC	26
Tube furnaces with stand for horizontal and vertical operation up to 1500 °C	RT	28
High-temperature tube furnaces with SiC rod heating up to 1600 °C	RHTC	29
High-temperature tube furnaces for horizontal or vertical operation up to 1800 °C	RHTH, RHTV	30
Working tubes		32
Gas supply systems/vacuum operation		34
Control alternatives for tube furnaces		38
Customized tube furnaces		39

Compact Tube Furnaces up to 1100 °C

The RD 30/200/11 tube furnace impresses with its very good price-performance ratio, particularly compact external dimensions and its low weight. This all-rounder is equipped with a working tube, which also serves as support for the heating wires. The working tube is therefore part of the furnace heating, with the advantage that the tube furnace reaches very high heating speeds. The furnace is designed for horizontal use up to 1100 °C.



Tube furnace RD 30/200/11

Standard Equipment

- Tmax 1100 °C
- Inner diameter of the tube: 30 mm, heated length: 200 mm
- Ceramic working tube C 530 including two fiber plugs for operation under air
- Thermocouple type K (1100 °C)
- Heating wires wound directly around the working tube resulting in very fast heat-up rates
- Controller R7, alternative controllers see page 84

Additional Equipment

- Over-temperature limiter with adjustable cutout temperature as temperature limiter to protect the furnace and load
- Gas supply system 1 for non-flammable process gas see page 34

Model	Tmax ¹ in °C	Outer dimensions ² in mm			Inner tube Ø in mm	Heated length in mm	Length constant temperature ¹ +/- 5 K in mm	Max. connected load in kW	Heating time ³ in min	Electrical connection [*]	Weight in kg
		W	D	H							
RD 30/200/11	1100	350	200	350	30	200	65	1.65	20	1-phase	12

¹Values outside the tube. Difference to temperature inside the tube up to + 50 K

²External dimensions vary when furnace is equipped with additional equipment. Dimensions on request.

³Heating time of the empty and closed furnace up to Tmax - 100 K (connected to 230 V 1/N/PE)

^{*}Please see page 84 for more information about supply voltage



Controller R7



Gas panel for one non-flammable process (N₂, Ar, He, CO₂, air, forming gas)



Example of an over-temperature limiter

Compact Tube Furnaces up to 1300 °C

These compact tube furnaces with integrated control systems can be used universally for many processes. Equipped with a standard working tube of C 530 ceramic and two fiber plugs, these tube furnaces have a very good price/performance ratio.



Tube furnace R 170/1000/13



Tube furnace R 50/250/13 with gas supply system 2

Standard Equipment

- Tmax 1200 °C or 1300 °C
- Single-zoned design
- Outer tube diameter of 50 mm to 170 mm, heated length from 250 mm to 1000 mm
- Ceramic working tube C 530 including two fiber plugs for operation under air see page 32
- Thermocouple type N (1200 °C) or type S (1300 °C)
- Heating elements on support tubes provide for free radiation see page 38
- Controller with touch operation B510 (5 programs with each 4 segments), alternative controllers see page 84

Additional Equipment

- Over-temperature limiter with adjustable cutout temperature as temperature limiter to protect the furnace and load
- Charge control with temperature measurement in the working tube see page 38
- Three-zoned design (heated length from 500 mm) for optimization of temperature uniformity
- Alternative working tubes see page 32
- Gas supply systems 1, 15, 2 or 4 see page 34

Model	Tmax ¹	Outer dimensions ³ in mm			Outer tube Ø in mm	Heated length in mm	Length constant ¹ temperature +/- 5 K in mm		Tube length in mm	Max. connected load in kW	Electrical connection*	Weight in kg
	in °C	W ²	D	H			single-zoned	three-zoned				
R 50/250/12	1200	434	340	508	50	250	80	-	450	1.9	1-phase	22
R 50/500/12	1200	670	340	508	50	500	170	250	700	3.4	1-phase	34
R 120/500/12	1200	670	410	578	120	500	170	250	700	6.6	3-phase	44
R 170/750/12	1200	920	460	628	170	750	250	375	1070	10.6	3-phase	74
R 170/1000/12	1200	1170	460	628	170	1000	330	500	1400	13.7	3-phase	89
R 50/250/13	1300	434	340	508	50	250	80	-	450	1.9	1-phase	22
R 50/500/13	1300	670	340	508	50	500	170	250	700	3.4	1-phase	34
R 120/500/13	1300	670	410	578	120	500	170	250	700	6.6	3-phase	44
R 170/750/13	1300	920	460	628	170	750	250	375	1070	12.0	3-phase	74
R 170/1000/13	1300	1170	460	628	170	1000	330	500	1400	13.7	3-phase	89

¹Values outside the tube. Difference to temperature inside the tube up to + 50

²Without tube

³External dimensions vary when furnace is equipped with additional equipment. Dimensions on request.

*Please see page 84 for more information about supply voltage



Tube furnace R 50/500/12 with three zone control



Gas panel for one non-flammable process (N₂, Ar, He, CO₂, air, forming gas)



Thermocouple for charge control

Split-Type Tube Furnaces for Horizontal or Vertical Operation up to 1300 °C

These tube furnaces can be used for horizontal (RSH) or vertical (RSV) operation. The split-type design makes it easy to change the working tube. It allows for a comfortable exchange of various working tubes (e.g. working tubes made of different materials).

Using a wide range of accessories, these professional tube furnaces can be optimally tailored for your process. By adding different gas supply packages, you can work in a protective gas atmosphere, with gases or in a vacuum. In addition to the convenient standard controllers, modern PLC controls can also be used to control the process.



Tube furnace RSH 50/500/13



Tube furnace RSV 170/1000/11 with gas-tight quartz glass working tube and water-cooled vacuum flanges

Standard Equipment

- Tmax 1100 °C or 1300 °C
- Single-zoned design
- RSV models with frame for vertical operation
- Split-type design for simple insertion of the working tube (opening temperature < 180 °C)
- Ceramic working tube C 530 including two fiber plugs for operation under air see page 32
- Thermocouple type N (1100 °C) or type S (1300 °C)
- Heating elements on support tubes provide for free radiation see page 38
- RSH: switchgear and control unit integrated in furnace housing
- RSH: controller with touch operation B510 (5 programs with each 4 segments), alternative controllers see page 84
- RSV: switchgear and control unit separate from furnace in own wall or standing cabinet
- RSV: controller with touch operation B500 (5 programs with each 4 segments), alternative controllers see page 84

Additional Equipment

- Charge control with temperature measurement in the working tube see page 38
- Three-zone control for optimization of temperature uniformity see page 38
- Alternative working tubes see chart page 32
- Cooling systems for accelerated cooling of the working tube and charge
- Gas supply systems 1, 15 or 2 for non-flammable process gas operation see page 34
- Gas supply system 4 for hydrogen operation see page 36
- Vacuum package to evacuate the working tube see page 37



Tube furnace RSH 80/500/13 with gas-tight quartz glass working tube and air-cooled vacuum flanges (gas supply system 15)

Model	Tmax ¹ in °C	Outer dimensions ² in mm			Max. outer tube Ø in mm	Heated length in mm	Length constant temperature ¹ +/- 5 K in mm		Tube length in mm	Max. connected load in kW		Electrical connection ⁴	Weight in kg
		W ³	D	H			single zoned	three zoned		1100 °C	1300 °C		
RSH 50/250/..		420	385	510	50	250	80	-	450	1.9	1.9	1-phase	25
RSH 50/500/..		670	385	510	50	500	170	250	700	3.4	3.4	1-phase ⁴	36
RSH 80/500/..		670	450	580	80	500	170	250	850	6.6	6.6	3-phase ⁴	46
RSH 80/750/..		920	500	920	80	750	250	375	1100	10.6	12.0	3-phase ⁴	76
RSH 80/1000/..	1100	1170	500	920	80	1000	330	500		13.7	13.7	3-phase ⁴	91
RSH 120/500/..	or	670	450	580	120	500	170	250	850	6.6	6.6	3-phase ⁴	46
RSH 120/750/..	1300	920	500	920	120	750	250	375	1100	10.6	12.0	3-phase ⁴	76
RSH 120/1000/..		1170	500	920	120	1000	330	500	1350	13.7	13.7	3-phase ⁴	91
RSH 170/750/..		920	500	920	170	750	250	375	1100	10.6	12.0	3-phase ⁴	76
RSH 170/1000/..		1170	500	920	170	1000	330	500	1350	13.7	13.7	3-phase ⁴	91
RSV 50/250/..		410	585	975	50	250	80	-	450	1.9	1.9	1-phase	25
RSV 50/500/..		410	585	1225	50	500	170	250	700	3.4	3.4	3-phase ⁴	36
RSV 80/500/..		480	585	1225	80	500	170	250	850	6.6	6.6	3-phase ⁴	46
RSV 80/750/..		540	635	1480	80	750	250	375	1100	10.6	12.0	3-phase ⁴	76
RSV 80/1000/..	1100	540	635	1730	80	1000	330	500		13.7	13.7	3-phase ⁴	91
RSV 120/500/..	or	480	585	1225	120	500	170	250	850	6.6	6.6	3-phase ⁴	46
RSV 120/750/..	1300	540	635	1480	120	750	250	375	1100	10.6	12.0	3-phase ⁴	76
RSV 120/1000/..		540	635	1730	120	1000	330	500	1350	13.7	13.7	3-phase ⁴	91
RSV 170/750/..		540	635	1480	170	750	250	375	1100	10.6	12.0	3-phase ⁴	76
RSV 170/1000/..		540	635	1730	170	1000	330	500	1350	13.7	13.7	3-phase ⁴	91

¹Values outside the tube. Difference to temperature inside the tube up to + 50 K

²External dimensions vary when furnace is equipped with additional equipment. Dimensions on request.

³Without tube

⁴At 3-phase execution an N conductor ist required (3/N/PE)

*Please see page 84 for more information about supply voltage



Tube furnace RSH 80/500/13 with gas tight tube and water-cooled flanges



RSH 120/500/11S with sliding furnace



RSH 210/1000/11S with quartz glass working tube and gas supply package 2

Rotary Tube Furnaces for Batch Operation up to 1100 °C

The rotary tube furnaces of the RSRB series are suited for batch operation. The rotation of the working tube ensures that the charge is in motion. Due to the shape of the quartz reactor with the tapered pipe ends the batch is kept in the rotary tube furnace and can be heat-treated an arbitrarily long time period time. A controlled heating to the temperature profiles is also possible.



Rotary tube furnace RSRB 80/500/11 as tabletop version for batch operation

Standard Equipment

- Tmax 1100 °C
- Single-zoned design
- Thermocouple type N
- Heating elements on support tubes provide for free radiation see page 38
- Tube furnace designed as table-top model with quartz glass reactor which opens on both sides, tapered ends
- Reactor is removed for emptying out of the rotary tube furnace. Beltless drive and hinged furnace housing (opening temperature < 180 °C) provide for very easy removal through
- Adjustable drive of approx. 1-40 rpm
- Controller with touch operation B510 (5 programs with each 4 segments), alternative controllers see page 84

Additional Equipment

- Charge control with temperature measurement in the working tube see page 38
- Three-zone control for optimization of temperature uniformity see page 38
- Reactor open on both sides, made of quartz glass with knobs for better mixing of the charge in the tube
- Gas supply system 25 for operation under non-flammable process gases with a gas-tight rotating outlet see page 34
- Gas supply system 4 for hydrogen operation see page 36
- Vacuum package for evacuating the working tube, depending on the pump used up to 10^{-2} mbar see page 37
- Left/right tilting device for easier loading and unloading of the work tube
 - For filling, the furnace is tilted to the right to convey the batch into the furnace. After the heat treatment, the furnace is swiveled to the opposite side for emptying, in order to convey the product out of the reactor again. It is not necessary to remove the reactor.
 - Mixing reactor made of quartz glass with integrated blade for better mixing of the batch, closed on one side, large opening on the opposite side
 - Rotary tube furnace assembled on base with integrated switchgear and controller, incl. transport casters



Rotary tube furnace RSRB 120/750/11 S with tilting mechanism to the left/to the right



RSRB 170/1000/11 H₂ with gas supply package 4 for hydrogen application

Model	Tmax ¹ in °C	Outer dimensions ² in mm (Table-top model)			Max. outer tube Ø in mm	Ø Terminal end in mm	Heated length in mm	Length constant Temperature ¹ +/- 5 K in mm		Tube length in mm	Max. connected load in kW	Electrical connection*	Weight in kg
		W	D	H				single zoned	three zoned				
RSRB 80/500/11	1100	1200	445	580	76	28	500	170	250	1140	6.6	3-phase	100
RSRB 80/750/11	1100	1450	495	630	76	28	750	250	375	1390	10.6	3-phase	115
RSRB 120/500/11	1100	1200	445	580	106	28	500	170	250	1140	6.6	3-phase	105
RSRB 120/750/11	1100	1450	495	630	106	28	750	250	375	1390	10.6	3-phase	120
RSRB 120/1000/11	1100	1700	495	630	106	28	1000	330	500	1640	13.7	3-phase	125

¹Values outside the tube. Difference to temperature inside the tube up to + 50 K

²External dimensions vary when furnace is equipped with additional equipment. Dimensions on request.

*Please see page 84 for more information about supply voltage



Gas tight closing plug for tubes made of quartz glass closed at one side as additional equipment



Gas tight rotating union with gas cooler and charge thermocouple

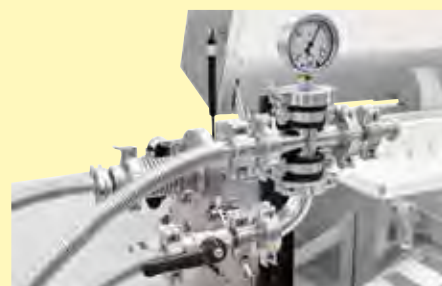

Connection set for vacuum operation

Rotary Tube Furnaces for Processes with Continuous Movement up to 1300 °C

The rotary tube furnaces of the RSRC series are particularly suitable for processes in which continuously running batch material is heated short-time. These rotary furnaces can be used very flexibly for various purposes. The rotary tube furnace is slightly inclined and brought to the target temperature. The material is then fed continuously at the top of the pipe. It passes through the heated zone of the tube and falls out of the pipe at the lower end. The time of the heat treatment depends on the angle of inclination, the speed of rotation and the length of the working tube, as well as from the flow properties of the batch material. Equipped with the optionally available closed feeding system, the rotary tube furnace can also be used for processes in a defined atmosphere or in a vacuum. Depending on the process, batch and required maximum temperature, work tubes made of different materials are used.



Rotary tube furnace RSRC 120750/13

Standard Equipment

- Tmax 1100 °C
 - Working tube made of quartz glass open at both sides
 - Thermocouple type N
- Tmax 1300 °C
 - Open ceramic tube C 530
 - Thermocouple type S
- Heating elements on support tubes provide for free radiation see page 38
- Adjustable drive of approx. 0.5-20 rpm
- Digital display unit for the tilting angle of the rotary tube furnace
- Split-type furnace housing (opening temperature < 180 °C) provide for easy tube change
- Compact system, rotary tube furnace positioned on a base frame with
 - Manual spindle drive with crank to set the tilting angle
 - Switchgear and controls integrated
 - Castors
- Controller with touch operation B500 (5 programs with each 4 segments), alternative controllers see page 84

Additional Equipment

- Charge control with temperature measurement in the working tube see page 38
- Three-zone control for optimization of temperature uniformity see page 38
- Alternative work tubes for different process requirements see page 32
- Quartz glass batch reactors (Tmax 1100 °C)
- Higher temperatures up to 1500 °C available on request
- Vibrating channel on the rotary tube for convenient material supply, suitable for processes in air
- Powder discharge tube for easy material discharge, suitable for processes in air
- Feeding system for the continuous delivery of 5 liters of material under a defined atmosphere or vacuum, consisting of:
 - Stainless steel funnel incl. electric vibration unit to optimize the material feeding into the working tube
 - Electrically driven screw-conveyor at the inlet of the working tube with 10, 20 or 40 mm pitch and adjustable speed between 0.25 and 20 rpm
 - Collecting bottle made of laboratory glass at the outlet of the working tube
- Gas supply package 26 for operation under non-flammable process gases (only in connection with the feeding system) see page 34
- Gas supply package 4 for hydrogen applications (only in connection with feeding system) see page 36
- Vacuum package for evacuating the working pipe, depending on the pump used up to 10⁻² mbar see page 37



Vibration unit at the charging funnel for improved powder supply



Rotary tube furnace RSRC 80/500/11 with feeding system and gas supply system 26 for processes under protective gas

Model	Tmax ¹ in °C	Outer dimensions ² in mm			Max. outer tube Ø in mm	Heated length in mm	Length constant Temperature ¹ +/- 5 K in mm		Tube length in mm	Max. connected load in kW	Electrical connection*	Weight in kg
		W	D	H			single zoned	three zoned				
RSRC 80/500/11	1100	1770	1050	1310	80	500	170	250	1540	6.7	3-phase	305
RSRC 80/750/11	1100	2020	1050	1360	80	750	250	375	1790	10.8	3-phase	340
RSRC 120/500/11	1100	1770	1050	1310	110	500	170	250	1540	6.7	3-phase	305
RSRC 120/750/11	1100	2020	1050	1360	110	750	250	375	1790	10.8	3-phase	340
RSRC 120/1000/11	1100	2270	1050	1360	110	1000	330	500	2040	13.9	3-phase	350
RSRC 80/500/13	1300	1770	1050	1310	80	500	170	250	1540	6.7	3-phase	305
RSRC 80/750/13	1300	2020	1050	1360	80	750	250	375	1790	12.2	3-phase	340
RSRC 120/500/13	1300	1770	1050	1310	110	500	170	250	1540	6.7	3-phase	305
RSRC 120/750/13	1300	2020	1050	1360	110	750	250	375	1790	12.2	3-phase	340
RSRC 120/1000/13	1300	2270	1050	1360	110	1000	330	500	2040	13.9	3-phase	350

¹Values outside the tube. Difference to temperature inside the tube up to + 50 K

²External dimensions vary when furnace is equipped with additional equipment. Dimensions on request.

*Please see page 84 for more information about supply voltage

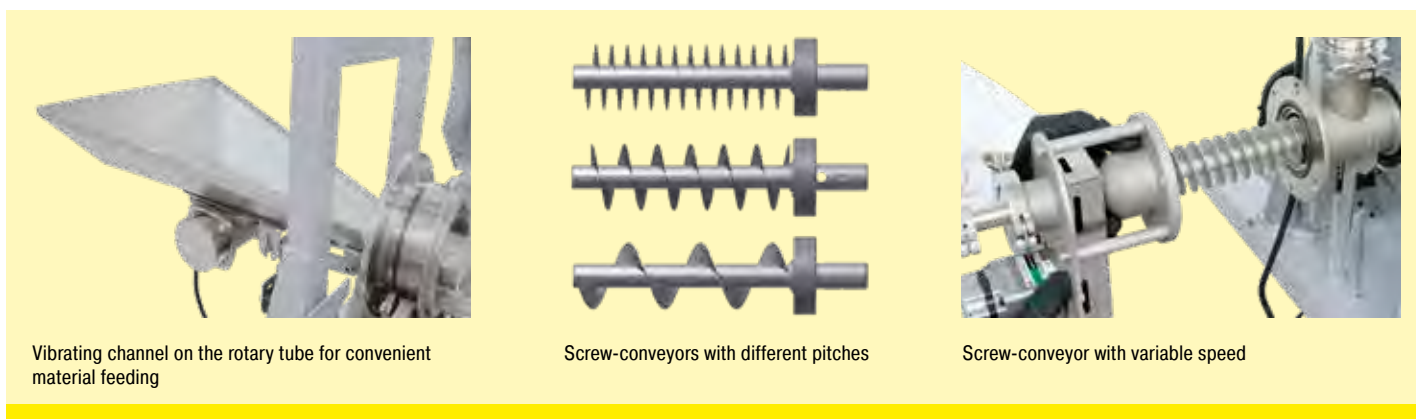

Vibrating channel on the rotary tube for convenient material feeding

Screw-conveyors with different pitches

Screw-conveyor with variable speed

Tube Furnaces with Stand for Horizontal and Vertical Operation up to 1500 °C

These compact tube furnaces are used when laboratory experiments must be performed horizontally, vertically, or at specific angles. The ability to configure the angle of tilt and the working height, and their compact design, also make these tube furnaces suitable for integration into existing process systems.



Tube furnace RT 50/250/13

Standard Equipment

- Tmax 1100 °C, 1300 °C, or 1500 °C
- Compact design
- Vertical or horizontal operation infinitely adjustable
- Angle infinitely adjustable from 0° to 90°
- Working height infinitely adjustable
- Operation also possible without stand if safety guidelines are observed
- Ceramic working tube C 530 including two fiber plugs for operation under air
- Type S thermocouple
- Heating wires wound directly around the working tube resulting in very fast heat-up rates
- Control system integrated in furnace base
- Controller with touch operation B510 (5 programs with each 4 segments), alternative controllers see page 84

Additional Equipment

- Over-temperature limiter with adjustable cutout temperature as temperature limiter to protect the furnace and load
- Gas supply system 1 for non-flammable process gas see page 34

Model	Tmax ¹ in °C	Outer dimensions ² in mm			Inner tube Ø in mm	Heated length in mm	Length constant temperature ¹ +/- 5 K in mm	Tube length in mm	Max. connected load in kW	Electrical connection*	Weight in kg
		W	D	H							
RT 50/250/11	1100	350	380	740	50	250	80	360	2	1-phase	25
RT 50/250/13	1300	350	380	740	50	250	80	360	2	1-phase	25
RT 30/200/15	1500	445	475	740	30	200	70	360	2	1-phase	45

¹Values outside the tube. Difference to temperature inside the tube up to + 50 K

²External dimensions vary when furnace is equipped with additional equipment. Dimensions on request.

*Please see page 84 for more information about supply voltage



Horizontal operation



Gas panel for one non-flammable process gas (N₂, Ar, He, CO₂, air, forming gas)



Example of an over-temperature limiter

High-Temperature Tube Furnaces with SiC Rod Heating up to 1600 °C

These compact tube furnaces with SiC rod heating and integrated switchgear with controller can be used universally for many processes. They represent an inexpensive variant in the high-temperature range. The standard mounting options for accessories make them flexible in use for a wide range of applications. The SiC heating elements arranged parallel to the working tube provide for an excellent temperature uniformity.



Tube furnace RHTC 80/450/16

Standard Equipment

- Tmax 1600 °C
- Working temperature 1500 °C, increased wear and tear must be expected in case of working at higher temperatures
- Active cooling of housing for low surface temperatures
- Ceramic working tube C 799 including two fiber plugs for operation under air see page 32
- Type S thermocouple
- SiC heating elements, easy to replace
- Controller with touch operation P580 (50 programs with each 40 segments), alternative controllers see page 84

Additional Equipment

- Over-temperature limiter with adjustable cutout temperature as temperature limiter to protect the furnace and load
- Charge control with temperature measurement in the working tube see page 38
- Alternative working tubes see page 32
- Gas supply systems 1, 2 or 4 see page 34

Model	Tmax ¹ in °C	Outer dimensions ² in mm			Outer tube Ø in mm	Heated length in mm	Length constant temperature ^{1, 6} +/- 5 K in mm	Tube length in mm	Max. connected load in kW	Electrical connection*	Weight in kg
		W	D	H							
RHTC 80/230/16	1600 ⁵	600	440	585	80	230	120	600	7.4	3-phase ³	50
RHTC 80/450/16	1600	820	440	585	80	450	210	830	11.0	3-phase ⁴	70
RHTC 80/710/16	1600	1075	440	585	80	710	345	1080	13.4	3-phase ⁴	90

¹Values outside the tube. Difference to temperature inside the tube up to + 50 K

²External dimensions vary when furnace is equipped with additional equipment. Dimensions on request.

³Heating only between phase 1 and neutral

⁴Heating only between two phases

*Please see page 84 for more information about supply voltage

⁵For standard equipment

⁶For standard equipment. Tmax 1500 °C with gas supply systems

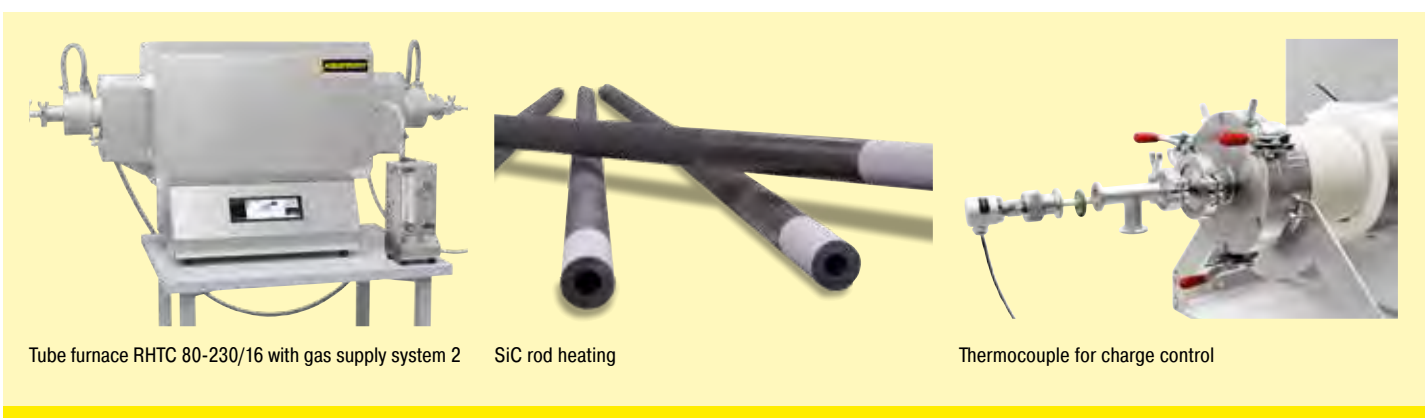

Tube furnace RHTC 80-230/16 with gas supply system 2

SiC rod heating

Thermocouple for charge control

High-Temperature Tube Furnaces for Horizontal or Vertical Operation up to 1800 °C

The high-temperature tube furnaces are available in either horizontal (type RHTH) or vertical (type RHTV) designs. High-quality insulation materials made of vacuum-formed fiber plates enable energy-saving operation due to low heat storage and heat conductivity. By using different gas supply systems, operations can be performed under non-flammable or flammable process gases or under vacuum.



Tube furnace RHTV 50/150/17 with stand and gas supply system 2

Standard Equipment

- Tmax 1600 °C, 1700 °C, or 1800 °C
- Single-zoned design
- Insulation with vacuum-formed ceramic fiber plates
- Tube furnaces RHTV with frame for vertical operation
- Type B thermocouple
- Ceramic working tube C 799 including two fiber plugs for operation under air see page 32
- Hanging and easy to change MoSi₂ heating elements
- Power unit with low-voltage transformer and thyristor
- Over-temperature limiter with adjustable cutout temperature as temperature limiter to protect the furnace and load
- Switchgear and control unit separate from furnace in separate floor standing cabinet
- Controller with touch operation P570 (50 programs with each 40 segments), alternative controllers see page 84

Additional Equipment

- Charge control with temperature measurement in the working tube see page 38
- Three-zone control for optimization of temperature uniformity (only horizontal tube furnaces RHTH) see page 38
- Alternative working tubes see page 32
- Gas supply system 2 for non-flammable process gas operation see page 34
- Gas supply system 4 for hydrogen operation see page 36
- Vacuum package to evacuate the working tube see page 37



RHTH 80/300/18 tube furnace with water-cooled flanges and charge control

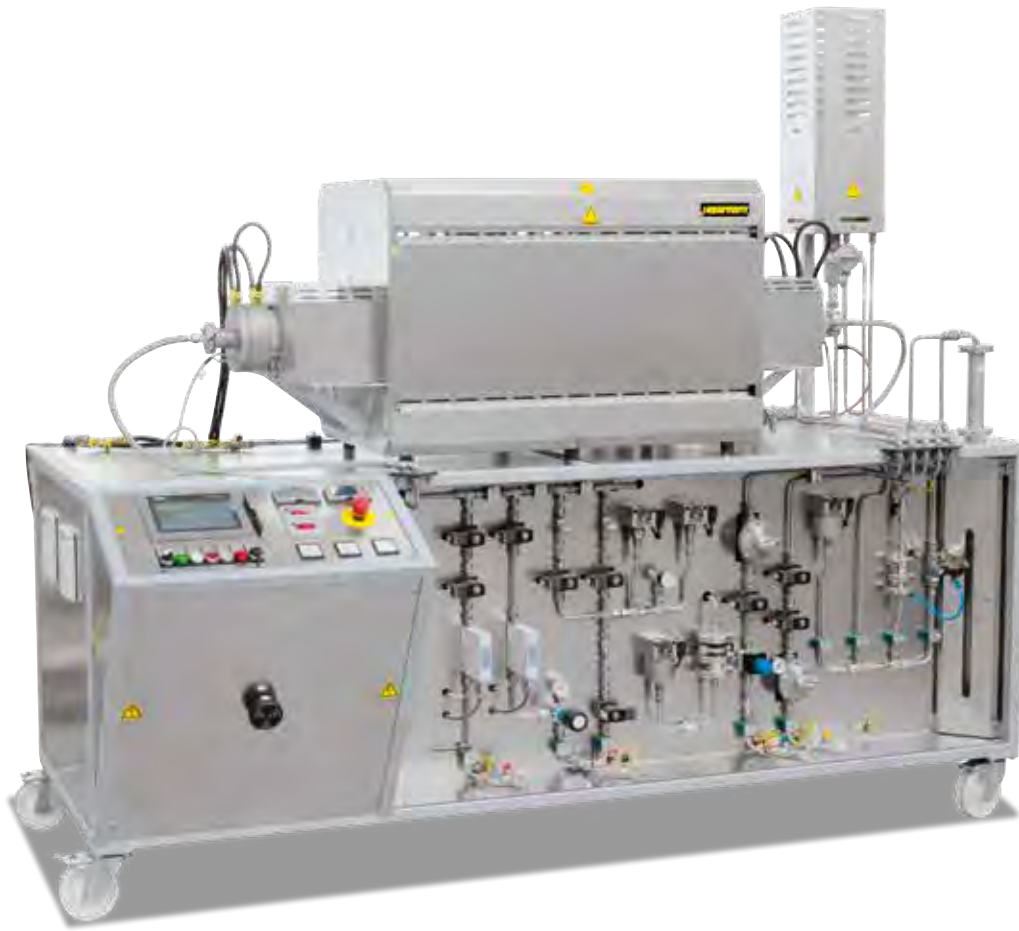

RHTH 120/600/18 with gas supply system 4 for operation with hydrogen

Model Horizontal design	Tmax ¹ in °C	Outer dimensions ³ in mm			Max. outer tube Ø in mm	Heated length in mm	Length constant temperature ¹ +/- 5 K in mm		Tube length in mm	Connected load in kW	Electrical connection* in kg	Weight
		W ²	D	H			single zoned	three zoned				
RHTH 50/150/..	1600 or	530	480	640	50	150	50	70	380	5.8	3-phase ⁴	70
RHTH 80/300/..	1700 or	680	550	640	80	300	100	150	530	9.4	3-phase ⁴	90
RHTH 120/600/..	1800	980	550	640	120	600	200	300	830	14.8	3-phase ⁴	110

Model Vertical design	Tmax ¹ in °C	Outer dimensions ³ in mm			Max. outer tube Ø in mm	Heated length in mm	Length constant temperature ¹ +/- 5 K in mm	Tube length in mm	Connected load in kW	Electrical connection* in kg	Weight
		W	D	H ²							
RHTV 50/150/..	1600 or	610	700	1130	50	150	30	380	5.8	3-phase ⁴	70
RHTV 80/300/..	1700 or	680	700	1280	80	300	80	530	10.7	3-phase ⁴	90
RHTV 120/600/..	1800	680	700	1580	120	600	170	830	19.4	3-phase ⁴	110

¹Values outside the tube. Difference to temperature inside the tube up to + 50 K

²Without tube

³External dimensions vary when furnace is equipped with additional equipment. Dimensions on request.

⁴Heating only between two phases

*Please see page 84 for more information about supply voltage



Tube furnace RHTH 120/600/17



Sintering under hydrogen in a tube furnace of RHTH product line



Example of over-temperature limiter

Working Tubes

There are various working tubes available, depending on application and temperatures. The technical specifications of the different working tubes are presented in the following table:



Material	Tube outside Ø in mm	Max. heat-up ramp in K/h	Tmax in air ³ in °C	Tmax in vacuum operation in °C	Gas tight
C 530 (Sillimantin) ¹	< 120 from 120	unlimited 200	1300	not possible	no
C 610 (Pythagoras) ¹	< 120 from 120	300 200	1400	1200	yes
C 799 (Alsint 99.7 %) ¹	< 120 from 120	300 200	1800	1400	yes
Quartz glass ²	all	unlimited	1100	950	yes
FeCrAl-Alloy ² (APM)	all	unlimited	1300	1100	yes

¹Tolerances with respect to form and position acc. to DIN 40680

²All dimensions are nominal dimensions, tolerances on request

³The max. allowed temperature might be reduced operating under aggressive atmospheres

Various working tubes as option

Measurements outer Ø x inner Ø x length	Article No. ⁴		Rotary tube furnace, continuous operation										Batch operation				
	work tube	spare tube	RSRC										RSRB				
			1100 °C					1300 °C					1100 °C				
			80-500	80-750	120-500	120-750	120-1000	80-500	80-750	120-500	120-750	120-1000	80-500	80-750	120-500	120-750	120-1000
Ceramic tube C 530																	
80 x 65 x 1540 mm	6000058702	691404536	○					●									
80 x 65 x 1790 mm	6000058701	691404537		○		○			●		○						
80 x 65 x 2040 mm	6000058700	691404538				○						○					
110 x 95 x 1540 mm	6000058704	691404539			○					●							
110 x 95 x 1790 mm	6000058703	691403376				○						●					
110 x 95 x 2040 mm	6000058216	691404540					○						●				
Ceramic tube C 610																	
80 x 65 x 1540 mm	6000058707	691404541	○					○									
80 x 65 x 1790 mm	6000058706	691404542		○		○			○		○						
80 x 65 x 2040 mm	6000058705	691404543				○						○					
110 x 95 x 1540 mm	6000058709	691404544			○						○						
110 x 95 x 1790 mm	6000058708	691404561				○						○					
110 x 95 x 2040 mm	6000052969	691403437					○						○				
Quartz glass tube																	
76 x 70 x 1540 mm	6000058947	691404545	●					○		○							
76 x 70 x 1790 mm	6000054644	691404546		●		○			○		○						
76 x 70 x 2040 mm	6000058946	691404547				○						○					
106 x 100 x 1540 mm	6000058949	691403519			●						○						
106 x 100 x 1790 mm	6000058948	691403305				●						○					
106 x 100 x 2040 mm	6000030741	691404548					●						○				
Quartz glass tube with pimple																	
76 x 70 x 1540 mm	6000058953	691404549	○					○									
76 x 70 x 1790 mm	6000058952	691404550		○		○			○		○						
76 x 70 x 2040 mm	6000058951	691404551				○						○					
106 x 100 x 1540 mm	6000058956	691404552			○						○						
106 x 100 x 1790 mm	6000058955	691403442				○						○					
106 x 100 x 2040 mm	6000058954	691404553					○						○				
CrFeAl-Alloy																	
75 x 66 x 1540 mm	601405296	691405357	○		○			○		○							
75 x 66 x 1790 mm	601405297	691405231		○		○			○		○						
109 x 99 x 1540 mm	601405298	691403682			○					○							
109 x 99 x 1790 mm	601405299	691403607				○						○					
109 x 99 x 2040 mm	601405300	691405122					○						○				
Quartz glass reactor																	
76 x 70 x 1140 mm	601402746	691402548											●		○		
76 x 70 x 1390 mm	601402747	691402272												●		○	
106 x 100 x 1140 mm	601402748	691402629													●		
106 x 100 x 1390 mm	601402749	691402638														●	
106 x 100 x 1640 mm	600048571	600032705															●
Quartz glass reactor with pimples																	
76 x 70 x 1140 mm	601404723	691402804											○		○		
76 x 70 x 1390 mm	601404724	691403429												○		○	
106 x 100 x 1140 mm	601404725	691403355													○		
106 x 100 x 1390 mm	601404726	691403296														○	
Quartz glass mixing reactor																	
76 x 70 x 1140 mm	601404727	691403407												○			
76 x 70 x 1390 mm	601404728	691404554													○		
106 x 100 x 1140 mm	601404732	691404557														○	
106 x 100 x 1390 mm	601404733	691404558															○

● Standard working tube

○ Working tube available as an option

⁴Tubes/reactors incl. mounted sleeves for connection to the rotary drive. Spare tubes come without sleeves.

Working tube outer Ø x inner Ø x length	Article No.	Model																											
		R					RSH/RSV						RHTC			RHTH			RHTV										
		50-250	50-500	120-500	170-750	170-1000	50-250	50-500	80-500	80-750	120-500	120-750	120-1000	170-750	170-1000	80-230	80-450	80-710	50-150	80-300	120-600	50-150	80-300	120-600					
C 530																													
40 x 30 x 450 mm	692070274	○					○																						
40 x 30 x 700 mm	692070276		○	○				○	○				○																
50 x 40 x 450 mm	692070275	●					●																						
50 x 40 x 700 mm	692070277		●					●					○																
60 x 50 x 850 mm	692070305			○					○				○																
60 x 50 x 1100 mm	692070101																					○							
80 x 70 x 850 mm	692070108			○					●				○																
80 x 70 x 1100 mm	692070109						○		●																				
120 x 100 x 850 mm	692070110			●						●																			
120 x 100 x 1100 mm	692070111						○					●										○							
120 x 100 x 1350 mm	692070131							○						●															
170 x 150 x 1100 mm	692071659					●																●							
170 x 150 x 1350 mm	692071660						●																●						
Vacuum tube ¹ C 610																													
50 x 40 x 650 mm	692070207	○					○																						
50 x 40 x 900 mm	691405352		○					○																					
60 x 50 x 1230 mm	692070180			○						○																			
60 x 50 x 1480 mm	692070181					○					○																		
80 x 70 x 1230 mm	692070182					○				○																			
80 x 70 x 1480 mm	692070183					○				○																			
120 x 100 x 1230 mm	692070184					○					○																		
120 x 100 x 1480 mm	692070185					○						○																	
120 x 100 x 1730 mm	692070186						○							○															
170 x 150 x 1480 mm	692070187						○																						
170 x 150 x 1730 mm	692070188						○																						
C 799																													
50 x 40 x 380 mm	692071664																						●				●		
50 x 40 x 450 mm	691403622	○																											
50 x 40 x 530 mm	692071665																							○				○	
50 x 40 x 690 mm	692071714		○																										
50 x 40 x 830 mm	692070163																												
80 x 70 x 530 mm	692071669																												
80 x 70 x 600 mm	692070600																												
80 x 70 x 830 mm	692071670																												
80 x 70 x 1080 mm	692071647																												
120 x 105 x 830 mm	692071713																												
Vacuum tube ¹ C 799																													
50 x 40 x 990 mm	692070149																					○				○			
50 x 40 x 1140 mm	692070176																						○				○		
50 x 40 x 1440 mm	692070177																												
80 x 70 x 990 mm	692070190																						○						
80 x 70 x 1140 mm	692070148																												
80 x 70 x 1210 mm	692070191								○			○																	
80 x 70 x 1470 mm	692070192										○												○						
80 x 70 x 1440 mm	692070178																												
120 x 105 x 1440 mm	692070147																												
APM vacuum tube ² with grinded ends																													
51 x 38 x 650 mm	691406358	●						●																					
51 x 38 x 900 mm	691406359		●						●																				
51 x 38 x 1480 mm	691406360					○						○													○				
51 x 38 x 1730 mm	691406361																									○			
60 x 52 x 1230 mm	691406362					○																							
60 x 52 x 1480 mm	691406363							○																					
60 x 52 x 1730 mm	691406364																												
75 x 66 x 1230 mm	691406206					○																							
75 x 66 x 1480 mm	691406365						○					●																	
75 x 66 x 1730 mm	691406366							○																					
115 x 104 x 1230 mm	691406367						●																						
115 x 104 x 1480 mm	691406325							○																					
115 x 104 x 1730 mm	691406368																												
164 x 152 x 1480 mm	691406339																												
164 x 152 x 1730 mm	691406370																												
Vacuum quartz glass tube																													
50 x 40 x 650 mm	691403182	○																											
50 x 40 x 900 mm	691406024		○																										
60 x 54 x 1030 mm	691404422																												
60 x 54 x 1230 mm	691404423					○																							
60 x 54 x 1480 mm	691404424																												
80 x 74 x 1230 mm	691404425																												
80 x 74 x 1480 mm	691404426																												
120 x 114 x 1230 mm	691404427																												
120 x 114 x 1480 mm	691404428																												
120 x 114 x 1730 mm	691404429																												
170 x 162 x 1480 mm	691404430																												
170 x 162 x 1730 mm	691404431																												

Gas Supply Systems/Vacuum Package for Tube Furnaces

When equipped with different gas supply systems, most tube furnace product lines can be adapted for operation with non-flammable or flammable gases or for vacuum operation.



Fiber plug with protective gas connection, suitable for many laboratory applications (gas supply system 1)

Gas Supply System 1

For Non-Flammable Process Gases in Static Tube Furnaces, not Gas-Tight

Gas supply system 1 is a basic version for static tube furnaces, for operation with non-flammable process gases. This system is not completely gas-tight and can therefore not be used for vacuum operation.

Standard Equipment

- Available for RD, R, RT, RHTC, RSH and RSV tube furnaces
- Two plugs made of porous, non-classified ceramic fiber incl. protective gas connections
- The standard working tube supplied with the furnace can be used
- Gas panel for one non-flammable process gas (N_2 , Ar, He, CO_2 , air, forming gas*)
- Shut-off valve and flow meter with manual valve
- Supply of gas with 300 mbar required

Additional Equipment

- Additional gas panels for further non-flammable gases
- Automatic segment-related switching on/off by a magnetic valve
- Bottle pressure reducer for use with bottled gas

Gas Supply Systems 15 and 2

for Non-Flammable Process Gases in Static Tube Furnaces, Gas-Tight

For increased atmospheric purity requirements in the working tube in static tube furnaces we recommend one of these gas-tight gas supply systems with stainless steel flanges on the end of the tube is recommended.

The less expensive gas supply system 15 for furnaces up to 1300 °C and working tubes to 120 mm diameter is available for R, RSH and RSV tube furnaces. It includes contact protection on the flange and a stainless steel type 1.4301 heat radiation protection insert for the tube ends to protect the seals. A heat radiation protection package cools the flanges and a water connection is thus not required. With this variant, the tube must not be opened while it is hot. It is also not suitable for applications with a turbomolecular pump to achieve high vacuum. Gas supply system 2 is the correct choice for this type of application.

Gas supply system 2 with water-cooled flanges is available for R, RHTC, RHTH, RHTV, RSH and RSV furnaces. Cooling water supply with NW9 hose connector to be provided by the customer.



Flange with heat radiation protection insert (gas supply system 15)



Water-cooled vacuum flange (gas supply system 2)

Standard Equipment

- Extended gas-tight working tube made of C 610 for furnaces up to 1300 °C or C 799 for temperatures above 1300 °C
- Two vacuum-tight stainless steel flanges with KF flange on the outlet side
- Mounting system on furnace for the flanges

* Country-specific regulations for permissible mixture ratios must be observed.



Water-cooled stainless steel flanges with quick locks as additional equipment

- Gas panel for one non-flammable process gas (N₂, Ar, He, CO₂, air, forming gas*)
- Shut-off valve and flow meter with manual valve
- Supply of gas with 300 mbar required
- Check valve in the gas outlet to prevent air entering



Window as additional equipment for gas-tight flanges

Additional Equipment for Gas Supply Systems 15 and 2

- Additional gas panels for further non-flammable gases
- Automatic segment-related switching on/off by a magnetic valve
- Bottle pressure reducer for use with bottled gas
- Vacuum package for a maximum final pressure of up to 5×10^{-5} mbar

Other Additional Equipment only for Gas Supply System 2

- Quick-locks for water-cooled flanges
- Air-water heat exchanger for closed loop water circuit
- Window for charge observation

Gas Supply Systems 25 and 26

for Non-Flammable Process Gases in Rotary Tube Furnaces, Gas-Tight

Gas supply systems for non-flammable process gases are also available for RSRB and RSRC rotary tube furnaces.



Gas panel for one non-flammable process gas (N₂, Ar, He, CO₂, air, forming gas*)

Standard Equipment

- Gas panel for one non-flammable process gas (N₂, Ar, He, CO₂, air, forming gas*)
- Shut-off valve and flow meter with manual valve
- Supply of gas with 300 mbar required

Gas supply system 25 for rotary tube furnaces for batch operation (RSRB) also includes gas-tight rotary lead-outs on the gas inlet and outlet as well as a gas cooler at the outlet. A check valve is also installed at the gas outlet to prevent air entering the tube.

For gas supply system 26 for rotary tube furnaces for continuous processes (RSRC) the furnace must also be equipped with a feeding system.

Additional Equipment

- Additional gas panels for further non-flammable gases
- Automatic segment-related switching on/off by a magnetic valve
- Bottle pressure reducer for use with bottled gas
- Vacuum package for a maximum final pressure of up to 5×10^{-2} mbar

* Country-specific regulations for permissible mixture ratios must be observed.



Example of an over-temperature limiter

Gas Supply System 4 for Hydrogen Applications in Tube Furnaces from Room Temperature

Gas supply system 4 allows operation with a hydrogen atmosphere starting at ambient temperature. During hydrogen operation, a pressure of approx. 30 mbar is ensured in the working tube. At the gas outlet the hydrogen is burnt off in an exhaust gas torch. Equipped with a safety PLC control system, pre-purging, hydrogen inlet, operation, fault monitoring and purging at the end of the process are carried out automatically (with at least five times the volume of the tube). If a malfunction occurs, the tube is immediately purged with nitrogen and the system is automatically switched to a safe status.



Gas panels with mass flow controllers

Standard Equipment

- Available for R, RHTC, RHTH, RHTV, RSH, RSV, RSRB and RSRC tube furnaces
- Gas panel for hydrogen and nitrogen
- Automatic segment-related switching on/off by a magnetic valve
- Control via safety PLC control system with touch panel
- Exhaust gas torch with temperature monitoring
- Over-temperature limiter with digital display as over-temperature protection for the furnace and charge
- Excess pressure monitoring
- Emergency purge container for nitrogen



Example of a torch

Additional Equipment

- Additional gas panels for further non-flammable gases
- Operation with other flammable gases
- Gassing via program-related controllable mass flow controllers
- Bottle pressure reducer for use with bottled gas
- Air-water heat exchanger for closed loop water circuit (apart from RSRB and RSRC)



Furnace-unrelated measuring device for a pressure range of 10^{-3} mbar or 10^{-9} mbar

Assignment of Gas Supply Systems to Furnace Models

Model	Gas supply system					
	1	15	2	25	26	4
RD	●					
R	●	●	●			●
RT	●					
RHTC	●		●			●
RHTH			●			●
RHTV			●			●
RSH	●	●	●			●
RSV	●	●	●			●
RSRB					●	●
RSRC						●

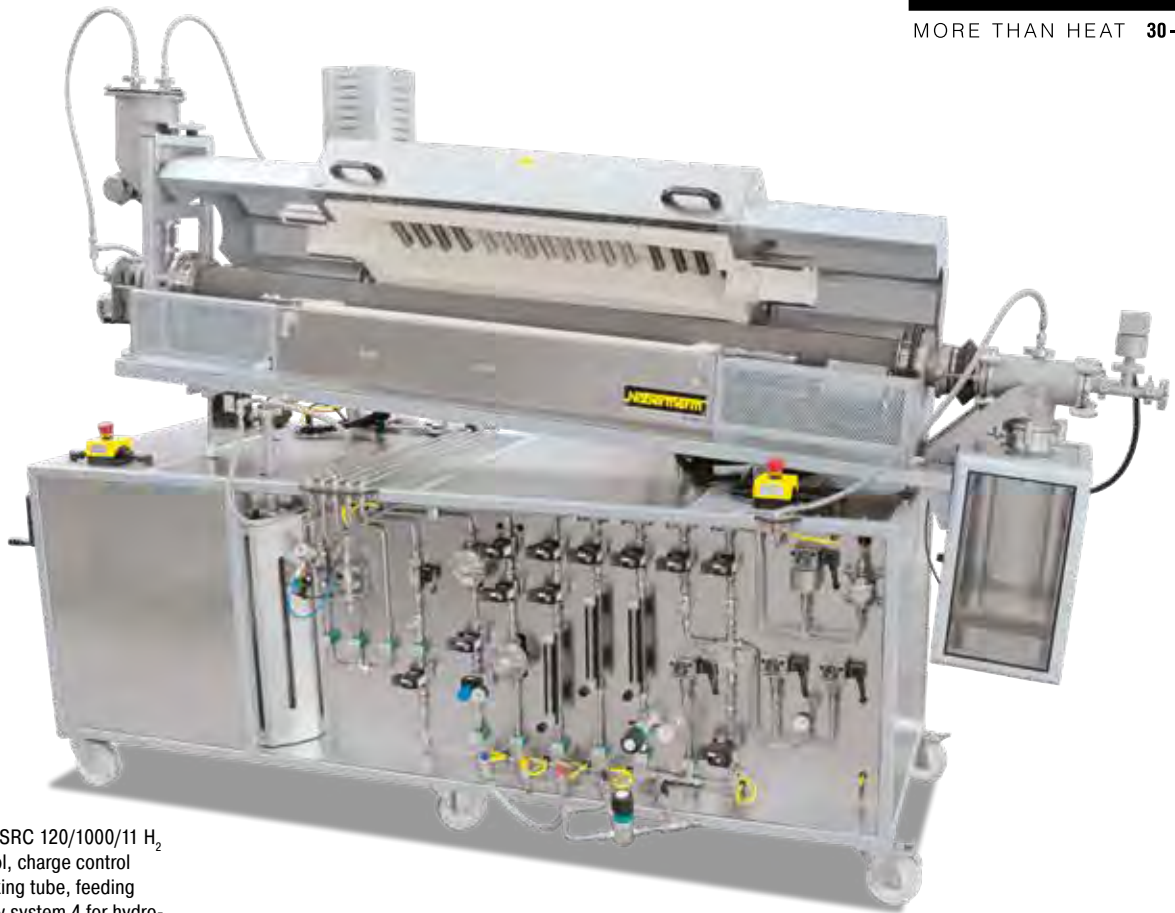

Rotary tube furnace RSRC 120/1000/11 H₂ with three-zone control, charge control as well as FeCrAl working tube, feeding system and gas supply system 4 for hydrogen operation

Vacuum Package

The vacuum package enables the working tube to be evacuated for vacuum operation in tube furnaces. It consists of an intermediate component for the gas outlet, a ball valve, a pressure gauge and a manually operated vacuum pump that is connected to the gas outlet by a corrugated stainless steel hose. A gas-tight furnace system is required for the use of a vacuum package, e.g. with the gas-supply packages 15, 2, 25 or 26. To protect the vacuum pump, only cold stage evacuation is allowed. The pump can then remain switched during the running program. The maximum ultimate pressure in the working tube depends on the type of pump.

- Single-stage rotary vane pump for an achievable ultimate pressure of approx. 20 mbar
- Two-stage rotary vane pump for an achievable ultimate pressure of approx. 5×10^{-2} mbar
- Turbomolecular pump system, consisting of a diaphragm pump with downstream turbomolecular pump for an achievable ultimate pressure of up to approx. 5×10^{-5} mbar (not for models RSRB and RSRC and not in combination with gas supply package 15)



Single-stage rotary vane pump (similar to picture)



Two-stage rotary vane pump (similar to picture)



Turbomolecular pump with upstream pump (similar to picture)

Controls for Tube Furnaces

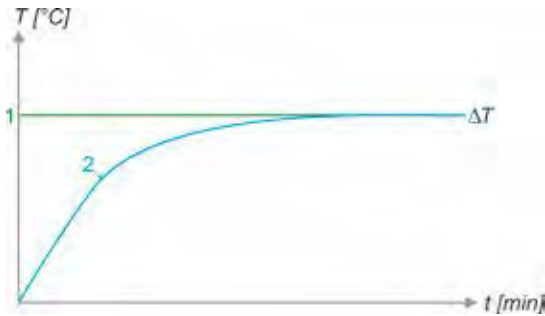

Furnace control

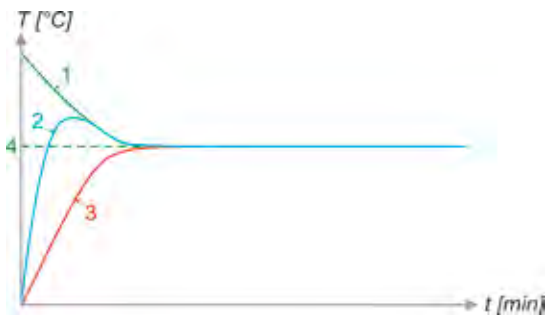

Charge control

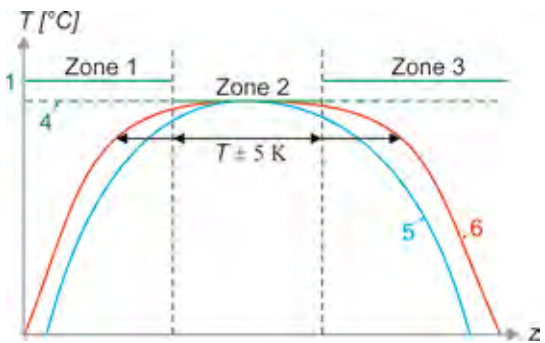

Three-Zone Furnace Chamber Control

1. Set value furnace chamber
2. Actual value furnace chamber
3. Actual value charge
4. Set value charge
5. Actual value furnace chamber single zone
6. Actual value furnace chamber three zone

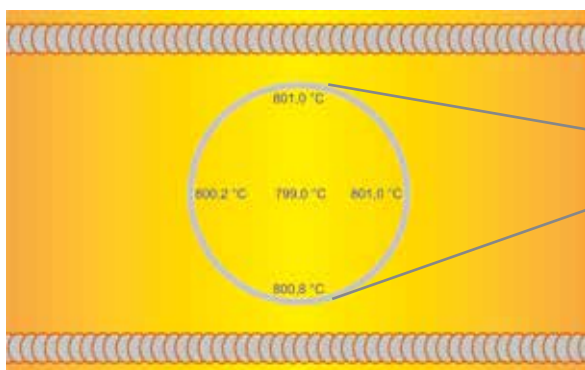

Temperature uniformity, measured in tube furnace RSH 170/750/13

Furnace Chamber and Charge Controls

With the furnace chamber control, the temperature is only measured in the furnace chamber outside the working tube. This protects the thermocouples from damage and aggressive batch. The control is slow to avoid overshoots. Since the temperature inside the working tube is not measured in this mode, a significant temperature difference can occur between the batch temperature inside the tube and the furnace chamber temperature displayed in the controller.

With an additional charge thermocouple, the "charge control" mode can measure the temperature in the furnace as well as the temperature inside the working tube. This enables the batch temperature to be controlled very precisely and quickly. Charge control can be used with all tube furnaces, with the exception of the RD and RT series.

Three-Zone Furnace Chamber Controls

The heated length is divided into three heating zones. The temperature is measured via one thermocouple per zone, which is positioned outside the working tube between the heating wires. The side zones are controlled via a setpoint offset in relation to the middle zone. In this way, the heat loss at the tube ends can be compensated in order to achieve an extended zone of constant temperature (± 5 K).

Freely Radiating Heating Elements

A very good temperature uniformity is achieved with the freely radiating heating elements on support tubes.



Customized Tube Furnaces



Tube furnace RS 200/4500/08 with lift door for heat treatment of bars



RHTV 120/600/17 H₂ with gas supply system 4 for flammable gases, swiveling hook for hanging the batch and safety door in front of the lower flange



Hinged flange

With their high level of flexibility and innovation, Nabertherm offers the optimal solution for customer-specific applications. Based on our standard models, we develop individual solutions also for integration in overriding process systems. The solutions shown on this page are just a few examples of delivered furnaces. From processes working under vacuum or protective gas via innovative control and automation technology for a wide selection of temperatures, sizes, lengths and other properties of tube furnace systems – we will find the appropriate solution for a suitable process optimization.



RSH 320/2000/09 H₂ with three-zone control for heat treatment of precious metals



RS 120/1000/11S with bogie for different inclination angles

Ovens and Forced Convection Furnaces up to 850 °C

Drying processes or heat treatments at low temperatures benefit from forced air-circulation. The results are a better heat transfer and optimization of temperature uniformity. The Nabertherm ovens also impress with an attractive design made of a high-quality stainless steel housing.

The following equipment applies to all furnaces in this chapter:



Dual shell ventilated housing made of textured stainless steel sheets for low surface temperature and high stability



Solid state relays provide for lownoise operation



Exclusive use of insulation materials without categorization according to EC Regulation No 1272/2008 (CLP). This explicitly means that alumino silicate wool, also known as “refractory ceramic fiber” (RCF), which is classified and possibly carcinogenic, is not used.



Defined application within the constraints of the operating instructions



Controller with intuitive touch operation



NTLog Basic for Nabertherm controller: recording of process data with USB-flash drive



Freeware NTEdit for convenient program input via Excel™ for Windows™ on the PC



Freeware NTGraph for evaluation and documentation of firings using Excel™ for Windows™ on the PC



MyNabertherm App for online monitoring of the firing on mobile devices for free download



As additional equipment: Process control and documentation via VCD software package for monitoring, documentation and control



Furnace Group	Model	Page
Ovens up to 300 °C	TR	42
Chamber ovens up to 260 °C	KTR	44
Forced convection chamber furnaces up to 850 °C	NAT	46
Forced convection chamber furnaces up to 675 liter	NA	48
Ovens with safety technology	TR .. LS	50
Forced convection chamber furnaces up to 500 liter with safety technology	NA .. LS	51

Ovens up to 300 °C

With their maximum working temperature of up to 300 °C and forced air circulation, the ovens achieve a very good temperature uniformity. They can be used for various applications such as e.g. drying, sterilizing or warm storing. Short delivery times from stock are ensured for standard models.



Oven TR 240



Oven TR 450

Standard Equipment

- Tmax 300 °C
- Working temperature range: + 20 °C above room temperature up to 300 °C
- Ovens TR 60 - TR 420 designed as tabletop models
- Ovens TR 450 - TR 1050 designed as floor standing models
- Horizontal forced air circulation results in temperature uniformity according to DIN 17052-1 better than +/- 5 °C in the empty oven (with closed exhaust air flap) see page 77
- Stainless steel furnace housing, material no. 1.4016 (DIN)
- Stainless steel chamber, alloy 304 (AISI)/(DIN material no. 1.4301), rust-resistant and easy to clean
- Charging in multiple layers possible using removeable grids (number of removeable grids included, see table to the right)
- Large, wide-opening swing door, hinged on the right with quick release for models TR 60 - TR 240 and TR 450
- Double swing door with quick release for models TR 420, TR 800 and TR 1050
- Ovens TR 800 and TR 1050 equipped with transport castors
- Infinitely adjustable exhaust at the rear wall with operation from the front
- PID microprocessor control with self-diagnosis system
- Controller R7, alternative programmable controllers see page 84

Additional Equipment

- Over-temperature limiter with adjustable cutout temperature as temperature limiter to protect the furnace and load
- Fan speed of the air circulation fan can be reduced infinitely
- Window for charge observing
- Further removeable grids with rails
- Side inlet
- Electrical rotary device with Tmax 200 °C (associated sample holder will be individually adapted to the charge)
- Exhaust air duct DN 80
- Transport castors for models TR 240 - TR 450
- Upgrading available to meet the quality requirements of AMS2750G or FDA



Oven TR 420



Oven TR 1050 with double door

Model	Tmax in °C	Inner dimensions in mm			Volume in l	Outer dimensions ¹ in mm			Max. connected load in kW	Electrical connection*	Weight in kg	Minutes to Tmax ²	Grids included	Grids max.	Max. total load ³
		w	d	h		W	D	H							
TR 60	300	450	390	350	60	700	665	720	3.3	1-phase	90	25	1	4	120
TR 120	300	650	390	500	120	900	665	870	3.3	1-phase	120	45	2	7	150
TR 240	300	750	550	600	240	1000	840	970	3.3	1-phase	165	60	2	8	150
TR 420	300	1300	550	600	420	1550	910	990	6.7	3-phase	250	60	2	8	200
TR 450	300	750	550	1100	450	1000	840	1470	6.7	3-phase	235	60	3	15	180
TR 800	300	1200	680	1000	800	1470	1170	1520	6.7	3-phase	360	80	3	10	250
TR 1050	300	1200	680	1400	1050	1470	1170	1920	10.0	3-phase	450	80	4	14	250

¹External dimensions vary when furnace is equipped with additional equipment. Dimensions on request

²In the empty and closed oven, connected to 230 V 1/N/PE resp. 400 V 3/N/PE

³Max load per layer 30 kg

*Please see page 84 for more information about supply voltage



Oven TR 60 with observation window



Extricable metal grids to load the oven in different layers



Electrical rotating device (in this case with tailored platform for PARR autoclave containers)

Chamber Ovens up to 260 °C

The chamber ovens of the KTR range can be used for complex drying processes and heat treatment of charges to an application temperature of 260 °C. The high-performance air circulation enables optimum temperature uniformity throughout the work space. A wide range of accessories allow the chamber ovens to be modified to meet specific process requirements.



Chamber oven KTR 6125

Standard Equipment

- Tmax 260 °C
- Electrically heated (via a heating register with integrated chrome steel heating elements) or gas-fired (direct or indirect gas-fired including injection of the hot air into the intake duct)
- Temperature uniformity up to ± 3 °C according to DIN 17052-1 (for design without track cutouts) see page 77
- High-quality mineral wool insulation provides for outer temperatures of < 25 °C above room temperature
- High air exchange for fast drying processes
- Double-wing door for furnaces KTR 2300 and larger
- Over-temperature limiter with adjustable cutout temperature as temperature limiter to protect the oven and load
- Controller with touch operation B500 (5 programs with each 4 segments), alternative controllers see page 84



Chamber oven KTR 1500 with charging cart

Additional Equipment

- Direct or indirect gas-fired
- Base frame to charge the oven via a charging forklift
- Additional Door in the back for charging from both sides or to use the oven as lock between two rooms
- Fan system for faster cooling with manual or motorized control of the exhaust flaps
- Programmed opening and closing of exhaust air flaps
- Air circulation with speed control, recommendable for processes with light or sensitive charge
- Observation window and furnace chamber lighting
- Design for clean room heat treatment processes
- Rotating systems e. g. for tempering processes
- All KTR-models are also available with Tmax 300 °C
- Process control and documentation via VCD software package or Nabertherm Control Center (NCC) for monitoring, documentation and control see page 86/89



Chamber oven KTR 6250 with double doors in the front and in the back as well as guide-in tracks for use as sluice oven

Model	Tmax °C	Inner dimensions in mm			Volume in l	Outer dimensions ² in mm			Heating power in kW ¹	Electrical connection*
		w	d	h		W	D	H		
KTR 1000	260	1000	1000	1000	1000	1820	1430	1890	18	3-phase
KTR 1500	260	1000	1000	1500	1500	1820	1430	2390	18	3-phase
KTR 2000	260	1100	1500	1200	2000	1920	1930	2090	18	3-phase
KTR 2300	260	1250	1250	1500	2300	2120	1680	2460	27	3-phase
KTR 3100	260	1250	1250	2000	3100	2120	1680	2960	27	3-phase
KTR 3400	260	1500	1500	1500	3400	2370	1930	2460	45	3-phase
KTR 4500	260	1500	1500	2000	4500	2370	1930	2960	45	3-phase
KTR 4600	260	1750	1750	1500	4600	2620	2175	2480	45	3-phase
KTR 6000	260	2000	2000	1500	6000	2870	2430	2460	54	3-phase
KTR 6125	260	1750	1750	2000	6125	2620	2175	2980	45	3-phase
KTR 6250	260	1250	2500	2000	6250	2120	3035	2960	54	3-phase
KTR 8000	260	2000	2000	2000	8000	2870	2430	2960	54	3-phase
KTR 9000	260	1500	3000	2000	9000	2490	3870	2920	72	3-phase
KTR 12300	260	1750	3500	2000	12300	2620	4350	2980	90	3-phase
KTR 13250	260	1250	5000	2000	13250	2120	6170	2960	108	3-phase
KTR 16000	260	2000	4000	2000	16000	2870	4850	2960	108	3-phase
KTR 21300	260	2650	3550	2300	21300	3600	4195	3380	108	3-phase
KTR 22500	260	2000	4500	2500	22500	3140	5400	3500	108	3-phase

¹Depending on furnace design connected load might be higher

²External dimensions vary when furnace is equipped with additional equipment. Dimensions on request.

*Please see page 84 for more information about supply voltage



Drive-in ramp

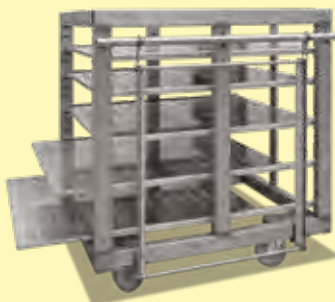

Charging cart with pull-out trays



Pull-out shelves, running on rolls

Forced Convection Chamber Furnaces – Tabletop Design electrically heated

These forced convection chamber furnaces are characterized by their good temperature uniformity. Due to the compact tabletop design, this series is very well suited for installation in laboratories or rooms with limited space.

Applications include preheating of components for shrink-fit processes, heat treatment of metals in air such as aging, stress relieving, soft annealing or tempering, and heat treatment of glass.



Forced convection chamber furnace NAT 15/85 with base frame as additional equipment

Standard Equipment

- Tmax 650 °C or 850 °C
- Horizontal air circulation with optimum distribution through stainless steel baffles
- Integrated control unit
- Swing door hinged on the right side, door opening temperatures up to 400 °C
- Temperature uniformity up to ± 6 °C according to DIN 17052-1 (model NAT 15/65 up to ± 5 °C) see page 77
- Optimum air distribution enabled by high flow speeds
- Air inlet in the rear wall of the furnace
- Adjustable exhaust port in the furnace ceiling (not for model NAT 15/65)
- 15 mm port in the furnace ceiling (not for model NAT 15/65)
- Controller with touch operation B500/B510 (5 programs with 4 segments each), controls description see page 84

Additional Equipment (not for NAT 15/65)

- Base frame
- Charging racks for loading on several levels
- Equipment package with batch control and process control and documentation via VCD software package



Forced convection chamber furnace NAT 30/65



Forced convection chamber furnace NAT 30/85



Forced convection chamber furnace NAT 50/85

Model	Tmax °C	Inner dimensions in mm			Volume in l	Outer dimensions ¹ in mm			Heating power in kW ²	Electrical connection*	Weight in kg	Heat-up time ³ to Tmax in minutes
		w	d	h		W	D	H				
NAT 15/65	650	295	340	170	15	470	790	460	2.8	1-phase	60	35
NAT 30/65	650	320	320	300	30	810	620	620	3.0	1-phase	90	80
NAT 60/65	650	400	400	400	60	890	700	720	3.0	1-phase	110	100
NAT 15/85	850	320	320	150	15	690	880	570	3.0	1-phase	85	190
NAT 30/85	850	320	320	300	30	690	880	720	3.0	1-phase	100	230
NAT 50/85	850	400	320	400	50	770	880	820	4.5	3-phase	130	230

¹External dimensions vary when furnace is equipped with additional equipment. Dimensions on request.

²Depending on furnace design connected load might be higher

³Approx. information in empty furnace

*Please see page 84 for more information about supply voltage



Adjustable exhaust port in the furnace ceiling



Forced convection chamber furnace NAT 15/85



Interior made of stainless steel sheet 1.4828

Forced Convection Chamber Furnaces up to 675 Liter electrically heated

The very good temperature uniformity of these chamber furnace with air circulation provides for ideal process conditions for annealing, curing, solution annealing, artificial ageing, sintering of PTFE, preheating, or soft annealing and brazing. The forced convection chamber furnaces are equipped with a suitable annealing box for soft annealing of copper or tempering of titanium, and also for annealing of steel under non-flammable process gases. The modular forced convection chamber furnace design allows for adaptation to specific process requirements with appropriate accessories.



Forced convection chamber furnace NA 120/65

Standard Equipment

- Tmax 450 °C, 650 °C, or 850 °C
- Horizontal air circulation with optimum distribution through stainless steel baffles
- Swing door hinged on the right side
- Base frame included in the delivery
- Temperature uniformity up to ± 4 °C according to DIN 17052-1 see page 77
- Optimum air distribution enabled by high flow speeds
- One frame sheet and rails for two additional trays included in the scope of delivery
- Controller with touch operation B500 (5 programs with 4 segments each), controls description see page 84

Additional Equipment for Models up to 450 °C

- Air inlet and exhaust air flaps when used for drying
- Controlled cooling via controlled flap and fan
- Additional frame sheet
- Gas supply boxes for different charging methods
- Gas feed fittings
- Charge control with documentation of the charge thermocouple
- Signal tower
- Charging systems

Further Additional Equipment for Models up to 850 °C

- Optimization of the temperature uniformity up to ± 3 °C according to DIN 17052-1 see page 77
- Measuring frames and thermocouples for TUS measurements charge or comparative measurements
- Version according to AMS2750G or CQI-9
- Manual lift door for forced convection chamber furnace NA 120/65 and NA 120/85
- Pneumatic lift door from forced convection chamber furnace NA 250/65 upwards
- Manual roller conveyor in furnace chamber for high charge weights



Forced convection chamber furnace NA 250/85



Forced convection chamber furnace NA 250/45



Forced convection chamber furnace NA 120/45 with fresh-air cooling as additional equipment

Model	Tmax	Inner dimensions in mm			Volume in l	Outer dimensions ¹ in mm			Heating power in kW ²	Electrical connection*	Weight in kg	Cool-down time ³ from Tmax to 150 °C in minutes		
	°C	w	d	h		W	D	H				Flaps ⁴	Fan cooling ⁴	
NA 120/45	450	450	600	450	120	1250	1550	1550	9.0	3-phase	460	60	240	30
NA 250/45	450	600	750	600	250	1350	1650	1680	12.0	3-phase	590	60	120	30
NA 500/45	450	750	1000	750	500	1550	1900	1820	18.0	3-phase	750	60	240	30
NA 60/65	650	350	500	350	60	930	1310	1450	9.0	3-phase	350	90	180	45
NA 120/65	650	450	600	450	120	1030	1410	1550	12.0	3-phase	400	90	240	60
NA 250/65	650	600	750	600	250	1250	1700	1750	20.0	3-phase	750	90	480	60
NA 500/65	650	750	1000	750	500	1400	1950	1900	27.0	3-phase	1000	90	600	90
NA 60/85	850	350	500	350	60	790	1330	1440	9.0	3-phase	315	150	900	120
NA 120/85	850	450	600	450	120	890	1420	1540	12.0	3-phase	390	150	900	120
NA 250/85	850	600	750	600	250	1120	1690	1810	20.0	3-phase	840	180	900	180
NA 500/85	850	750	1000	750	500	1270	1940	1960	30.0	3-phase	1150	180	900	210
NA 675/85	850	750	1200	750	675	1270	2190	1960	30.0	3-phase	1350	210	900	210

¹External dimensions vary when furnace is equipped with additional equipment. Dimensions on request.

²Depending on furnace design connected load might be higher

³Approx. information in empty furnace

⁴Additional equipment

*Please see page 84 for more information about supply voltage



Port for thermocouple



Tray



Roller conveyor in furnace chamber

Ovens with Safety Technology

for charges containing solvents according to EN 1539

Ovens in the TR .. LS range with safety equipment based on EN 1539 Type A are suitable for drying charges containing solvents. With their compact design, these ovens can be easily integrated into a laboratory or production process. Exhaust gases escape through an outlet on the back of the oven and can then be extracted or treated.



Standard Equipment

- Furnace technology based on ovens see page 42
- For a description of the safety technology refer to models NA ../45 LS
- Tmax 260 °C
- Temperature uniformity ± 8 K according to DIN 17052-1 in empty work space see page 77
- Controller with touch operation B510 (5 programs with 4 segments each), controls description see page 84

Additional Equipment

Refer to additional equipment for ovens on page 42

Oven TR 120 LS with safety technology according to EN 1539 for charges containing solvents

Model	Tmax °C	Inner dimensions in mm			Volume in l	Outer dimensions ³ in mm			Ma. connected load kW ²	Electrical connection*	Weight in kg	Minutes to Tmax ⁴	Grids		Total load max. ¹
		w	d	h		W	D	H					incl.	max.	
TR 60 LS	260	450	380	350	60	700	820	710	5.7	3-phase	100	20	1	4	96
TR 120 LS	260	650	380	500	120	900	820	870	6.7	3-phase	120	22	2	7	140
TR 240 LS	260	750	540	600	240	1000	990	970	6.7	3-phase	180	32	2	8	170
TR 450 LS	260	750	540	1100	450	1000	990	1470	13.3	3-phase	250	36	3	15	250

¹Maximum load per level 30 kg

²Connected load is higher with EN 1539 as additional equipment

³External dimensions vary when furnace is equipped with additional equipment. Dimensions on request.

⁴In empty, closed furnace when connected to 230 V 1/N/PE or 400 V 3/N/PE

*Please see page 84 for more information about supply voltage



Extricable metal grids to load the oven in different layers



Oven TR 60 S with rotary mechanism



Electrical rotating device (in this case with tailored platform for PARR autoclave containers)

Forced Convection Chamber Furnaces up to 500 Liter with Safety Technology for charges containing solvents according to EN 1539

Due to their very good temperature uniformity, these chamber furnaces with air circulation are especially suitable for processes such as drying paints or components with residues of flammable cleaning agents or the evaporation of solvents bound in the components.



Forced convection chamber furnace NA 120/45 LS

Standard Equipment

- Design based on forced convection chamber furnaces see page 48
- High-powered heating to maintain the required air exchange rates
- Powerful exhaust air fan to ensure underpressure in the furnace
- Defined and monitored air circulation and exhaust air
- Visual and audible malfunction signals
- Over-temperature limiter with manual reset as over-temperature protection for the furnace and the charge
- Controller with touch operation P570 (50 programs with each 40 segments), controls description see page 84

Additional Equipment

- EN 1539 with reduced exhaust air flow rate to 25 % after the main evaporation time to save energy
- EN 1539 with temporary switching off for processes in which no flammable substances are released

Model	Tmax in °C	Inner dimensions in mm			Volume in l	Outer dimensions ¹ in mm			Heating power in kW ²	Exhaust air flow rate in m ³ /h	Maximum volume of solvent in g at temperature:				
		w	d	h		W	D	H			75 °C	150 °C	250 °C	350 °C	450 °C
NA 120/45 LS	450	450	600	450	120	1250	1550	1950	18	100 - 120	51	20	9	5	4
NA 250/45 LS	450	600	750	600	250	1350	1650	2080	24	100 - 120	93	36	17	9	7
NA 500/45 LS	450	750	1000	750	500	1550	1900	2220	24	100 - 120	104	42	21	12	9

¹External dimensions vary when furnace is equipped with additional equipment. Dimensions on request.

²Depending on the furnace design, connected load might be higher



Sluice furnace N 560/26HACLS with safety package, loading from the front and unloading from the back



Fresh-air opening and powerful exhaust air fan installed on the furnace



Interior with metal shelf, thermocouples and pressure monitoring

Chamber Furnaces up to 1400 °C

Furnaces with sturdy insulation made from lightweight refractory bricks for rough use in the laboratory. These universal chamber furnaces with radiation heating have been specifically designed to withstand heavy-duty use in the tool shop and are available with many options such as gassing boxes or loading systems.

The following equipment applies to all furnaces in this chapter:



Dual shell ventilated housing made of textured stainless steel sheets for low surface temperature and high stability



Solid state relays provide for low noise operation



Exclusive use of insulation materials without categorization according to EC Regulation No 1272/2008 (CLP). This explicitly means that aluminosilicate wool, also known as "refractory ceramic fiber" (RCF), which is classified and possibly carcinogenic, is not used.



Defined application within the constraints of the operating instructions



Controller with intuitive touch operation



NTLog Basic for Nabertherm controller: recording of process data with USB-flash drive



Freeware NTEdit for convenient program input via Excel™ for Windows™ on the PC



Freeware NTGraph for evaluation and documentation of firings using Excel™ for Windows™ on the PC



MyNabertherm App for online monitoring of the firing on mobile devices for free download



As additional equipment: Process control and documentation via VCD software package for monitoring, documentation and control



Furnace Group	Model	Page
Chamber furnaces up to 1400 °C	LH, LF	54
Chamber furnaces up to 1280 °C	N .. H	56
Accessories for the heat treatment of metals		57

Chamber Furnaces with Brick Insulation or Fiber Insulation up to 1400 °C

These big chamber furnaces LH 15/12 - LF 120/14 have been trusted for many years as professional chamber furnaces for the laboratory. These furnaces are available with either a robust insulation of light refractory bricks (LH models) or with a combination insulation of refractory bricks in the corners and low heat storage, quickly cooling fiber material (LF models). With a wide variety of optional equipment, these chamber furnaces can be optimally adapted to your processes.



Chamber furnace LH 30/14

Standard Equipment

- Tmax 1200 °C, 1300 °C, or 1400 °C
- High furnace chamber with five-sided heating for very good temperature uniformity
- Heating elements on support tubes ensure free heat radiation and a long service life
- Controller mounted on furnace door and removable for comfortable operation
- Protection of bottom heating and flat stacking surface provided by embedded SiC plate in the floor
- LH models: multi-layered insulation of light refractory bricks and special backup insulation
- LF models: high-quality fiber insulation with corner bricks for shorter heating and cooling times
- Door with brick-on-brick seal, hand fitted
- Generously dimensioned heating provides for short heating times
- Self-supporting arch for high stability and greatest possible protection against dust
- Motorized exhaust air flaps
- Freely adjustable air inlet integrated in furnace floor
- Base included
- Controller with touch operation B500 (5 programs with each 4 segments), alternative controllers see page 84



Chamber furnace LH 216/12 with fresh air fan to accelerate the cooling times

Additional Equipment

- Parallel swinging door (user protected from heat radiation)
- Lift door with electro-mechanic linear drive for opening when hot
- Cooling system to cool the furnace with a defined temperature gradient or with a preset fresh air volume. Both operating modes can be switched on and off for different segments by means of the extra function of the controller.
- Protective gas connection to purge with non-flammable process gases
- Manual or automatic gas supply system
- Stainless steel exhaust hood as interface to customer's exhaust system
- Scale to measure weight reduction during annealing



Chamber furnace LH 30/12 with manual lift door



Chamber furnace LH 60/12 SW with scale to measure weight reduction during annealing

Model	Tmax in °C	Inner dimensions in mm			Volume in l	Outer dimensions ¹ in mm			Connected load in kW	Electrical connection*	Weight in kg
		w	d	h		W	D	H			
LH 15/12	1200	250	250	250	15	680	860	1230	5	3-phase ²	170
LH 30/12	1200	320	320	320	30	710	930	1290	7	3-phase ²	200
LH 60/12	1200	400	400	400	60	790	1180	1370	8	3-phase	300
LH 120/12	1200	500	500	500	120	890	1180	1470	12	3-phase	410
LH 216/12	1200	600	600	600	216	990	1280	1590	20	3-phase	470
LH 15/13	1300	250	250	250	15	680	860	1230	7	3-phase ²	170
LH 30/13	1300	320	320	320	30	710	930	1290	8	3-phase ²	200
LH 60/13	1300	400	400	400	60	790	1180	1370	11	3-phase	300
LH 120/13	1300	500	500	500	120	890	1180	1470	15	3-phase	410
LH 216/13	1300	600	600	600	216	990	1280	1590	22	3-phase	470
LH 15/14	1400	250	250	250	15	680	860	1230	8	3-phase ²	170
LH 30/14	1400	320	320	320	30	710	930	1290	10	3-phase ²	200
LH 60/14	1400	400	400	400	60	790	1180	1370	12	3-phase	300
LH 120/14	1400	500	500	500	120	890	1180	1470	18	3-phase	410
LH 216/14	1400	600	600	600	216	990	1280	1590	26	3-phase	470
LF 15/13	1300	250	250	250	15	680	860	1230	7	3-phase ²	150
LF 30/13	1300	320	320	320	30	710	930	1290	8	3-phase ²	180
LF 60/13	1300	400	400	400	60	790	1180	1370	11	3-phase	270
LF 120/13	1300	500	500	500	120	890	1180	1470	15	3-phase	370
LF 15/14	1400	250	250	250	15	680	860	1230	8	3-phase ²	150
LF 30/14	1400	320	320	320	30	710	930	1290	10	3-phase ²	180
LF 60/14	1400	400	400	400	60	790	1180	1370	12	3-phase	270
LF 120/14	1400	500	500	500	120	890	1180	1470	18	3-phase	370

¹External dimensions vary when furnace is equipped with additional equipment. Dimensions on request.

²Heating only between two phases

*Please see page 84 for more information about supply voltage



Parallel swinging door for opening when hot



Model with brick base



LF furnace design provides for shorter heating and cooling times

Chamber Furnaces for Annealing, Hardening and Brazing up to 1280 °C

To withstand harsh use in the laboratory, e.g. when heat-treating metals, robust insulation with light refractory bricks is necessary. The chamber furnaces N 7/H - N 87/H are a perfect fit to solve this problem. The furnaces can be extended with a variety of accessories, like annealing boxes for operation under protective gas, roller guides, or a cooling station with a quench tank. Even high-performance applications like the annealing of titanium in medical applications can be implemented without the use of expensive and complicated annealing systems.



Chamber furnace N 61/H

Standard Equipment

- Tmax 1280 °C
- Deep furnace chamber with three-sides heating: from both side walls and bottom
- Heating elements on support tubes ensure free heat radiation and a long service life
- Bottom heating protected by heat-resistant SiC plate
- Stainless steel upper door jamb protects furnace structure when furnace is opened hot
- Temperature uniformity up to +/- 10 °C according to DIN 17052-1 see page 77
- Low energy consumption due to multi-layer insulation
- Base frame included in the delivery, N 7/H - N 17/HR designed as table-top model
- Exhaust opening in the side of the furnace, or on rear wall of chamber furnace in the N 31/H models and higher
- Parallel guided downward swinging door (user protected from heat radiation)
- Door movement cushioned with gas dampers/struts
- Controller with touch operation B500 (5 programs with each 4 segments), alternative controllers see page 84

Model	Tmax in °C	Inner dimensions in mm			Volume in l	Outer dimensions ¹ in mm			Connected load in kW	Electrical connection*	Weight in kg	Heating time in min ²
		w	d	h		W	D	H				
N 7/H	1280	250	250	140	9	800	650	600	3.0	1-phase	60	320
N 11/H	1280	250	350	140	11	800	750	600	3.5	1-phase	70	320
N 11/HR	1280	250	350	140	11	800	750	600	5.5	3-phase ³	70	70
N 17/HR	1280	250	500	140	17	800	900	600	6.4	3-phase ³	90	110
N 31/H	1280	350	350	250	31	1040	1030	1340	15.0	3-phase	210	90
N 41/H	1280	350	500	250	41	1040	1180	1340	15.0	3-phase	260	105
N 61/H	1280	350	750	250	61	1040	1430	1340	20.0	3-phase	400	105
N 87/H	1280	350	1000	250	87	1040	1680	1340	25.0	3-phase	480	105

¹External dimensions vary when furnace is equipped with additional equipment. Dimensions on request.

²Heating time of the empty and closed furnace up to Tmax - 100 K (connected to 230 V 1/N/PE resp. 400 V 3/N/PE)

³Heating only between two phases

*Please see page 84 for more information about supply voltage



Working with protective gas boxes for a protective gas atmosphere using a charging cart



Chamber furnace N 7/H as table-top model



Deep furnace chamber with three-sides heating

Accessories for the Heat Treatment of Metals

Our wide range of furnaces for heat treatment of metals can be extended with a large selection of accessories to suit to the specific application.

Protective Gas Boxes for Heat Treatment in Protective Gas

By using protective gas boxes, annealing furnaces, forced convection furnaces and pit-type furnaces can be upgraded for heat treatment processes under non-flammable process gases.



Annealing Boxes

Annealing boxes are filled with powder or granules into which the charge is placed. Processes like soldering can be carried out in an inexpensive manner.



Complete Workshop Hardening Systems

The Nabertherm compact hardening systems consist of a hardening furnace, a tempering furnace, a quenching and cleaning bath. They can be used for various heat treatment processes in the workshop.



Quenching and Cleaning Baths

Baths for quenching in oil or water as well as for cleaning and degreasing are available as single or double baths and are made of stainless steel.



Auxiliary Materials for Better Charge Results

Hardening foils, annealing bags, granulate



Protective Equipment

Gloves, face and body protection



For more information about our extensive range of heat treatment accessories, please request our catalog "Thermal Process Technology 2"

High-Temperature Furnaces up to 1800 °C

In order to achieve the desired mechanical properties of ceramic parts, the components must be sintered at high temperatures after debinding. With the high-temperature chamber furnaces as table-top or floor-standing models for maximum temperatures between 1400 °C and 1800 °C, Nabertherm offers a wide range of furnace solutions that enable later scale-up for production.

The following equipment applies to all furnaces in this chapter:



Dual shell ventilated housing made of textured stainless steel sheets for low surface temperature and high stability



Stainless steel exhaust hood as interface to customer's exhaust system for all standing models



Exclusive use of insulation materials without categorization according to EC Regulation No 1272/2008 (CLP). This explicitly means that alumino silicate wool, also known as "refractory ceramic fiber" (RCF), which is classified and possibly carcinogenic, is not used.



Defined application within the constraints of the operating instructions



Controller with intuitive touch operation



NTLog Basic for Nabertherm controller: recording of process data with USB-flash drive



Freeware NTEdit for convenient program input via Excel™ for Windows™ on the PC



Freeware NTGraph for evaluation and documentation of firings using Excel™ for Windows™ on the PC



MyNabertherm App for online monitoring of the firing on mobile devices for free download



As additional equipment: Process control and documentation via VCD software package for monitoring, documentation and control



Furnace Group	Model	Page
High-temperature furnaces with MoSi ₂ heating elements Table-top model up to 1800 °C	LHT	60
High-temperature furnaces with SiC rod heating Table-top model up to 1600 °C	LHTC(T)	62
High-temperature bottom loading furnaces up to 1650 °C	LHT .. LB	63
High-temperature furnaces with scale up to 1750 °C	LHT .. SW	64
Combi high-temperature furnace LHT 08/17 BO up to 1750 °C with integrated catalytic post combustion	LHT .. BO	65
High-temperature furnaces with MoSi ₂ heating elements Floor-standing model up to 1800 °C	HT	66
High-temperature furnaces with SiC rod heating Floor-standing model up to 1550 °C	HTC	68
High-temperature furnaces with MoSi ₂ heating elements Refractory brick insulation up to 1700 °C	HFL	69

High-Temperature Furnaces with Molybdenum Disilicide Heating Elements up to 1800 °C

Designed as tabletop models, these compact high-temperature furnaces have a variety of advantages. The first-class workmanship using high-quality materials, combined with ease of operation, make these furnaces all-rounders in research and the laboratory. These high-temperature furnaces are also perfectly suited for the sintering of technical ceramics, such as zirconium oxide dental bridges.



High-temperature furnace LHT 02/17

Standard Equipment

- Tmax 1600 °C, 1750 °C, or 1800 °C
- Recommended working temperature 1750 °C (for models LHT ../18), increased wear and tear must be expected in case of working at higher temperatures
- High-quality heating elements made of molybdenum disilicide offer very good protection against chemical interaction between charge and heating elements
- Adjustable air inlet opening
- Exhaust air opening in the roof
- Thermocouple type B or type S (LHT ../17 D)
- Controller with touch operation P580 (50 programs with each 40 segments), controls description see page 84



High-temperature furnace LHT 01/17 D

Additional Equipment

- Over-temperature limiter with adjustable cutout temperature as temperature limiter to protect the furnace and load
- Port for thermocouple in the furnace roof
- Protective gas connection to purge with non-flammable process, not gas tight
- Manual or automatic gas supply system
- Stackable saggars for loading in up to two or three levels, depending on model, see page 17



High-temperature furnace LHT 03/17 D



High-temperature furnace LHT 08/18

Model	Tmax in °C	Inner dimensions in mm			Volume in l	Outer dimensions ¹ in mm			Max. connected load in kW	Electrical connection*	Weight in kg	Heating time in min ³
		w	d	h		W	D	H ²				
LHT 02/16	1600	130	145	130	2	430	450	570+325	2.7	1-phase	33	28
LHT 04/16	1600	160	175	160	4	450	475	610+335	2.7	3-phase ⁴	39	50
LHT 08/16	1600	200	200	200	8	500	500	650+370	5.3	3-phase ⁴	47	33
LHT 01/17 D	1650	110	120	120	1	385	425	525+195	2.7	1-phase	28	27
LHT 03/17 D	1650	135	135	200	4	412	450	595+300	2.7	1-phase	38	57
LHT 02/17	1750	130	145	130	2	430	450	570+325	2.7	1-phase	33	46
LHT 04/17	1750	160	175	160	4	450	475	610+335	2.7	3-phase ⁴	39	90
LHT 08/17	1750	200	200	200	8	500	500	650+370	5.3	3-phase ⁴	47	50
LHT 02/18	1800	130	145	130	2	430	450	570+325	2.7	1-phase	33	56
LHT 04/18	1800	160	175	160	4	450	475	610+335	2.7	3-phase ⁴	39	106
LHT 08/18	1800	200	200	200	8	500	500	650+370	5.3	3-phase ⁴	47	60

¹External dimensions vary when furnace is equipped with additional equipment. Dimensions on request.

²Including opened lift door

³Heating time of the empty and closed furnace up to Tmax –100 K (connected to 230 V 1/N/PE resp. 400 V 3/N/PE)

*Please see page 84 for more information about supply voltage

⁴Heating only between two phases



Saggars with top lid



Furnace chamber with high-quality fiber materials and heating elements made of molybdenum disilicide on both sides



Example of an over-temperature limiter

High-Temperature Furnaces with SiC Rod Heating up to 1600 °C

These powerful laboratory muffle furnaces are available for temperatures up to 1550 °C or 1600 °C. The durability of the SiC rods in periodic use, in combination with their high heating speed, make these high-temperature furnaces to all-rounders in the laboratory. Heating times of 25 - 30 minutes can be achieved, depending on the furnace model and the conditions of use.



High-temperature furnace LHTCT 01/16

Standard Equipment

- Tmax 1550 °C or 1600 °C
- Working temperature 1500 °C (for high-temperature furnaces LHTC ../16), increased wear and tear must be expected in case of working at higher temperatures
- Optional flap door (LHTC) which can be used as work platform or lift door (LHTCT) with hot surface facing away from the operator (High-temperature furnace LHTCT 01/16 only with lift door)
- Switching system with solid-state-relays, power tuned to the SiC rods
- Easy replacement of heating rods
- Adjustable air inlet opening, exhaust air opening in the roof
- Controller with touch operation C550 (10 programs with each 20 segments) see page 84

Additional Equipment

- Over-temperature limiter with adjustable cutout temperature as temperature limiter to protect the furnace and load
- Protective gas connection to purge with non-flammable process, not gas tight
- Manual or automatic gas supply system

Model	Tmax in °C	Inner dimensions in mm			Volume in l	Outer dimensions ¹ in mm			Max. connected load in kW	Electrical connection*	Weight in kg	Heating time in min ³
		w	d	h		W	D	H ²				
LHTCT 01/16	1550	110	120	120	1.5	340	335	485	3.5	1-phase	20	30
LHTC(T) 03/16	1600	120	210	120	3.0	415	545	490	8.2	3-phase ⁴	38	30
LHTC(T) 08/16	1600	170	290	170	8.0	490	625	540	12.5	3-phase	58	25

¹External dimensions vary when furnace is equipped with additional equipment. Dimensions on request.

²Plus maximum 255 mm for models LHTCT when open

³Heating time of the empty and closed furnace up to Tmax -100 K (connected to 230 V 1/N/PE resp. 400 V 3/N/PE)

*Please see page 84 for more information about supply voltage

⁴Heating only between two phases



High-temperature furnace LHTC 08/16



Gas supply system for non-flammable process gas

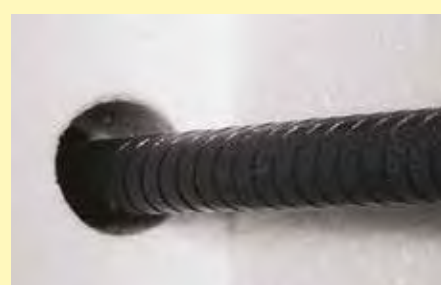

Furnace chamber with high-quality fiber materials and SiC heating rods on both sides of the furnace

High-Temperature Bottom Loading Furnaces with Molybdenum Disilicide Heating Elements and Fiber Insulation up to 1650 °C

The electrically driven lifting table significantly simplifies the charging of the high-temperature furnaces LHT ../.. LB Speed. The heating all around the cylindrical furnace chamber provides for an optimal temperature uniformity.



High-temperature furnace LHT 02/17 LB Speed with a set of saggars

Standard Equipment

- Tmax 1650 °C
- High-quality heating elements made of molybdenum disilicide offer very good protection against chemical interaction between charge and heating elements
- Very good temperature uniformity thanks to three (LHT 02/17 LB Speed) or four-sided (LHT 01/17 LB Speed) heating of the furnace chamber
- Furnace chamber with a volume of 1 or 2 liters, table with large floor space
- Precise, motorized toothed belt drive of the table with button operation
- Opening time of table approx. 30 sec., completely open
- Exhaust air vent in the roof
- Type S thermocouple
- Controller with touch operation P580 (50 programs with each 40 segments), controls description see page 84

Additional Equipment

- Over-temperature limiter with adjustable cutout temperature as temperature limiter to protect the furnace and load
- Stackable saggars for loading in up to two or three levels, depending on model, see page 17
- Reduced opening time of table to 10 sec., completely open
- Adjustable air inlet through the floor

Model	Tmax in °C	Work space dimensions ² in mm			Charging area in mm		Volume in l	Outer dimensions ¹ in mm			Max. connected load in kW	Electrical connection*	Weight in kg
		w	d	h	w	d		W	D	H			
LHT 01/17 LB Speed	1650	75	110	60	95	130	1	350	590	695	2.9	1-phase	45
LHT 02/17 LB Speed	1650	Ø 115		140	135	135	2	390	590	785	3.3	1-phase	55

¹External dimensions vary when furnace is equipped with additional equipment. Dimensions on request.

²Corresponds to charge saggars with spacer

*Please see page 84 for more information about supply voltage



Electrically driven lift-bottom



Saggars



Furnace chamber heated on four sides for model LHT 01/17 LB Speed

High-Temperature Furnaces with Scale for Determination of Combustion Loss and Thermogravimetric Analysis (TGA) up to 1750 °C

These high-temperature furnaces were specially developed to determine combustion loss during annealing and for thermogravimetric analysis (TGA) in the lab. The complete system consists of the high-temperature furnace for 1600 °C or 1750 °C, a table frame, precision scale with feedthroughs into the furnace and powerful software for recording both the temperature curve and the weight loss over time.

Standard Equipment

- Tmax 1600 °C or 1750 °C
- High-quality molybdenum disilicide heating elements
- Adjustable air inlet
- Exhaust air opening in the roof
- Type B thermocouple
- Delivery includes base, ceramic plunger with base plate in the furnace lining, precision scale and software package
- 4 scales available for different maximum weights and scaling ranges
- Process control and documentation for temperature and combustion loss via VCD software package for monitoring, documentation and control see page 84



High-temperature furnace LHT 04/16 SW with scale for measuring weight reduction during annealing

Model	Tmax in °C	Inner dimensions in mm			Volume in l	Outer dimensions ¹ in mm			Connected load in kW	Electrical connection*	Weight in kg	Heating time in min ²
		w	d	h		W	D	H				
LHT 04/16 SW	1600	150	150	150	4	655	370	890	5.0	3-phase ³	85	25
LHT 04/17 SW	1750	150	150	150	4	655	370	890	5.0	3-phase ³	85	30

¹External dimensions vary when furnace is equipped with additional equipment. Dimensions on request.

²Heating time of the empty and closed furnace up to Tmax –100 K (connected to 230 V 1/N/PE resp. 400 V 3/N/PE)

³Heating only between two phases

*Please see page 84 for more information about supply voltage

Scale type	Readability in g	Maximum weighing range in g	Weight of plunger in g	Calibration value in g	Minimum load in g
EW-2200	0.01	2200 incl. plunger	850	0.1	0.5
EW-4200	0.01	4200 incl. plunger	850	0.1	0.5
EW-6200	0.01	6200 incl. plunger	850	-	1.0
EW-12000	0.10	12000 incl. plunger	850	1.0	5.0



4 scales available for different maximum weights and scaling ranges

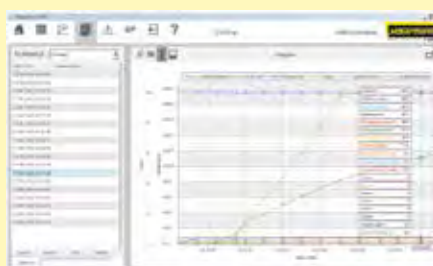

Graphic display of process curve

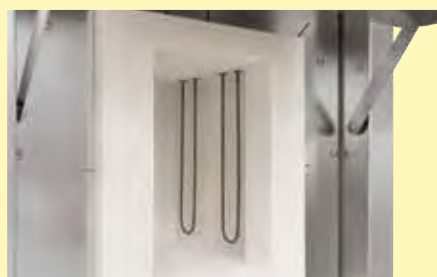

High-quality molybdenum disilicide heating elements

Combi High-Temperature Furnace LHT 08/17 BO up to 1750 °C with Integrated Catalytic Post Combustion

The combi furnace LHT 08/17 BO complements the muffle furnaces L .. /11 BO (see page 14) and provides a solution for debinding/ashing processes up to 600 °C with subsequent sintering processes at high temperatures. Specified with a maximum temperature of 1750 °C, the LHT 08/17 BO can be used for process temperatures up to 1700 °C. The compact size of the furnace makes it ideal for research and development applications but also for debinding and sintering of small additively manufactured components. The furnace can also be used to determine loss on ignition where, after the ashing process, the samples must be treated at temperatures above 1050 °C.

The combi furnace LHT 08/17 BO has a passive safety system with integrated exhaust gas post combustion. Fresh air is fed through the back of the furnace via an exhaust gas fan so that there is always sufficient oxygen available for the process. The incoming air is guided past the furnace heating and preheated which ensures good temperature uniformity. At the same time, exhaust gases are extracted from the furnace to the integrated post combustion system, where they are incinerated and catalytically cleaned.



Combi furnace LHT 08/17 BO

Standard Design

- Tmax 1750 °C
- Tmax 600 °C for the debinding/ashing process
- Recommended maximum working temperature approx. 50 °C below Tmax of the furnace. Higher working temperatures will increase wear and tear.
- Heating from two sides
- Spring-supported door closing (lift door) with mechanical lock to prevent unintended opening
- Thermal/catalytic post combustion in the exhaust air duct, to max. 600 °C furnace temperature in operation
- Temperature control of post combustion adjustable to 850 °C
- Fresh air preheated by additional heating element on the back wall of the furnace chamber
- Controller with touch operation P580 (50 programs each with 40 segments), for a description of the controls see page 84

Model	Tmax in °C ¹	Inner dimensions in mm			Volume in l	Outer dimensions ² in mm			Max. loading weight of organic substances in g	Max. evaporation rate of organic substances g/min	Connected load in kW	Electrical connection*	Weight in kg
		w	d	h		W	D	H ³					
LHT 08/17 BO	1750	150	250	150	6	530	705	695	75	1	13	3-phase	90

¹Tmax 600 °C für den Entbinderungs-/Veraschungsprozess

²External dimensions vary when furnace is equipped with additional equipment. Dimensions on request.

³Including exhaust tube (Ø 80 mm)

*Please see page 84 for more information about supply voltage



Combi furnace LHT 08/17 BO

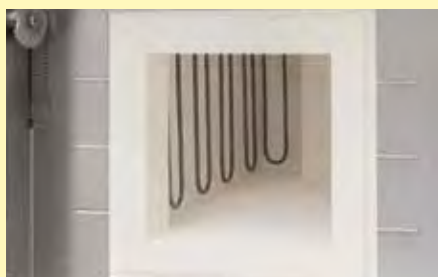

High-temperature heating in furnace chamber



Schematic representation of the air flow in combi furnace LHT 08/17 BO

High-Temperature Furnaces with Molybdenum Disilicide Heating Elements with Fiber Insulation up to 1800 °C

Due to their solid construction and compact stand-alone design, these high-temperature furnaces are perfect for processes in the laboratory where the highest precision is needed. Outstanding temperature uniformity and practical details set very high quality benchmarks. For configuration for your processes, these furnaces can be extended with extras from our extensive option list.



High-temperature furnace HT 29/17

Standard Equipment

- Tmax 1600 °C, 1750 °C, or 1800 °C
- Recommended maximum working temperature approx. 50 °C below Tmax of the furnace. Higher working temperatures will increase wear and tear.
- Heating from both sides via molybdenum disilicide heating elements
- High-quality fiber insulation backed by special insulation
- Long-life roof insulation with special suspension
- Temperature uniformity at 1450 °C up to ± 6 °C according to DIN 17052-1 see page 77
- Chain-guided parallel swivel door for precise opening and closing of the door
- Two-door design (front/back) for high-temperature furnaces from HT 276/..
- Labyrinth sealing ensures the least possible temperature loss in the door area
- Reinforced floor as protection for bottom insulation as standard from models HT 16/16 upwards (distributed load 5 kg/dm²)
- Vapor vent in the furnace roof with motorized exhaust air flaps, controlled via the extra function of the controller
- Stainless steel exhaust hood as interface to customer's exhaust system
- Controller with touch operation P570 (50 programs with each 40 segments), controls description see page 84

Additional Equipment

- Cooling system to cool the furnace with a defined temperature gradient or with a preset fresh air volume. Both operating modes can be switched on and off for different segments by means of the extra function of the controller.
- Safety package for debinding in air. Debinding technical ceramics is a critical process because of the hydrocarbons that are released. Hydrocarbons are flammable and there is a risk that a flammable mixture could form inside the furnace. Nabetherm offers tailored safety packages with respect to the process and the volume of binder that allow the furnace to be operated safely.
- Thermocouple inlet with screw cap
- Thermocouple for the heating control with calibration certificate
- Protective gas connection to purge with non-flammable process gases (not completely gas-tight)
- Automatic gas supply system with solenoid valve and rotameter, controlled by the extra function of the controller
- Refractory brick floor insulation for a higher floor load (Tmax 1700 °C)
- Lift door
- Automatic door lock incl. door contact switch
- Heating elements protected against mechanical damage
- Special heating element qualities e. g. for zircon oxide applications
- Ethernet interface



High temperature chamber furnace HT 450/16 with two locking devices per door



High-temperature furnace HT 160/17 with gas supply system



High-temperature furnace HT 64/17 with PLC controls and additional options

Model	Tmax °C	Inner dimensions in mm			Volume in l	Outer dimensions ¹ in mm			Connected load kW	Electrical connection*	Weight in kg
		w	d	h		W	D	H			
HT 08/16	1600	150	300	150	8	740	640	1755	8.5	3-phase ²	215
HT 16/16	1600	200	300	260	16	820	690	1860	12.5	3-phase ²	300
HT 29/16	1600	275	300	350	29	985	740	1990	9.8	3-phase ²	350
HT 40/16	1600	300	350	350	40	1010	800	1990	12.5	3-phase	420
HT 64/16	1600	400	400	400	64	1140	890	2040	18.5	3-phase	555
HT 128/16	1600	400	800	400	128	1140	1280	2040	26.5	3-phase	820
HT 160/16	1600	500	550	550	160	1250	1040	2260	21.5	3-phase	760
HT 276/16	1600	500	1000	550	276	1340	1600	2290	43.5	3-phase	1270
HT 450/16	1600	500	1150	780	450	1380	1820	2570	65.0	3-phase	1570
HT 08/17	1750	150	300	150	8	740	640	1755	8.5	3-phase ²	215
HT 16/17	1750	200	300	260	16	820	690	1860	12.5	3-phase ²	300
HT 29/17	1750	275	300	350	29	985	740	1990	9.8	3-phase ²	350
HT 40/17	1750	300	350	350	40	1010	800	1990	12.5	3-phase	420
HT 64/17	1750	400	400	400	64	1140	890	2040	18.5	3-phase	555
HT 128/17	1750	400	800	400	128	1140	1280	2040	26.5	3-phase	820
HT 160/17	1750	500	550	550	160	1250	1040	2260	21.5	3-phase	760
HT 276/17	1750	500	1000	550	276	1340	1600	2290	43.5	3-phase	1270
HT 450/17	1750	500	1150	780	450	1380	1820	2570	65.0	3-phase	1570
HT 08/18	1800	150	300	150	8	740	640	1755	8.5	3-phase ²	215
HT 16/18	1800	200	300	260	16	820	690	1860	12.5	3-phase ²	300
HT 29/18	1800	275	300	350	29	985	740	1990	9.8	3-phase ²	350
HT 40/18	1800	300	350	350	40	1010	800	1990	12.5	3-phase	420
HT 64/18	1800	400	400	400	64	1140	890	2040	18.5	3-phase	555
HT 128/18	1800	400	800	400	128	1140	1280	2040	26.5	3-phase	820
HT 160/18	1800	500	550	550	160	1250	1040	2260	21.5	3-phase	760
HT 276/18	1800	500	1000	550	276	1340	1600	2290	43.5	3-phase	1270
HT 450/18	1800	500	1150	780	450	1380	1820	2570	65.0	3-phase	1570

¹External dimensions vary when furnace is equipped with additional equipment. Dimensions on request.

²Heating only between two phases

*Please see page 84 for more information about supply voltage



Automatic gas supply system with solenoid valve and rotameter



Two-door design for high-temperature furnaces > HT 276/..



High-temperature furnace HT 160/18 DB200-3 with lift door

High-Temperature Furnaces with SiC Rod Heating and Fiber Insulation up to 1550 °C

The high-temperature furnaces HTC 16/16 - HTC 450/16 are heated by vertically hung SiC rods, which makes them especially suitable for sintering processes up to a maximum operating temperature of 1500 °C. For some processes, e. g. for sintering zirconium oxide, the reduction of interactivity between the charge and the SiC rods, these models are more suitable than the alternatives heated with molybdenum disilicide elements. The basic construction of these furnaces make them comparable with the already familiar models in the HT product line and they can be upgraded with the same additional equipment.



High-temperature furnace HTC 160/16

Standard Equipment

- Tmax 1550 °C
- Recommended maximum working temperature approx. 50 °C below Tmax of the furnace. Higher working temperatures will increase wear and tear.
- Heating from both sides via vertically mounted SiC rods
- High-quality fiber insulation backed by special insulation
- Long-life roof insulation with special suspension
- Temperature uniformity at 1450 °C up to +/- 6 °C according to DIN 17052-1 see page 77
- Chain-guided parallel swivel door for precise opening and closing of the door
- Two-door design (front/back) for high-temperature furnaces from HTC 276/.. up
- Labyrinth sealing ensures the least possible temperature loss in the door area
- Reinforced floor as protection for bottom insulation (distributed load 5 kg/dm²)
- Vapor vent in the furnace roof with motorized exhaust air flap, controlled via the extra function of the controller
- Stainless steel exhaust hood as interface to customer's exhaust system
- Controller with touch operation P570 (50 programs with each 40 segments), controls description see page 84

Additional Equipment like HT models see page 66

Model	Tmax in °C	Inner dimensions in mm			Volume in l	Outer dimensions ¹ in mm			Heating Power in kW	Connected load in kW	Electrical connection*	Weight in kg
		w	d	h		W	D	H				
HTC 16/16	1550	200	300	260	16	820	690	1860	12.0	16.5	3-phase ²	220
HTC 40/16	1550	300	350	350	40	1010	800	1990	12.0	16.5	3-phase	420
HTC 64/16	1550	400	400	400	64	1140	890	2040	18.0	41.5	3-phase	660
HTC 128/16	1550	400	800	400	128	1140	1280	2040	26.0	61.0	3-phase	550
HTC 160/16	1550	500	550	550	160	1250	1040	2260	21.0	40.0	3-phase	535
HTC 276/16	1550	500	1000	550	276	1340	1600	2290	36.0	73.0	3-phase	1300
HTC 450/16	1550	500	1150	780	450	1380	1820	2570	64.0	118.0	3-phase	1450

¹External dimensions vary when furnace is equipped with additional equipment. Dimensions on request.
²Heating only between two phases

*Please see page 84 for more information about supply voltage

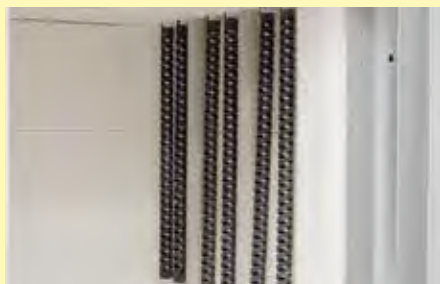

Vertically mounted SiC rods and optional perforated air inlet tubes of the debinding system in a high-temperature furnace



Two-door design for high-temperature furnaces > HT 276/..



Cooled inspection glass made out of sapphire glass (left at working temperature, right at room temperature)

High-Temperature Furnaces with Molybdenum Disilicide Heating Elements and Refractory Brick Insulation up to 1700 °C

High-temperature furnaces HFL 16/16 - HFL 160/17 have a sturdy cladding made from refractory insulation. This design offers better protection if the process produces aggressive gases or acids, such as when glass is melted.



Standard Equipment

Like high-temperature furnaces HT (see page 66), except:

- Tmax 1600 °C or 1700 °C
- Robust refractory brick insulation and special backing insulation
- Furnace floor made of lightweight refractory bricks accommodates higher charge weights

Additional Equipment

- Cooling system to cool the furnace with a defined temperature gradient or with a preset fresh air volume. Both operating modes can be switched on and off for different segments by means of the extra function of the controller.
- Thermocouple inlet with screw cap
- Thermocouple for the heating control with calibration certificate
- Protective gas connection to purge with non-flammable process gases (not completely gas-tight)
- Automatic gas supply system with solenoid valve and rotameter, controlled by the extra function of the controller
- Lift door
- Automatic door lock incl. door contact switch
- Heating elements protected against mechanical damage
- Ethernet interface

High-temperature furnace HFL 16/17 DB50 with gas supply system

Model	Tmax in °C	Inner dimensions in mm			Volume in l	Outer dimensions ¹ in mm			Connected load in kW	Electrical connection*	Weight in kg
		w	d	h		W	D	H			
HFL 16/16	1600	200	300	260	16	1010	890	1990	12.5	3-phase ²	530
HFL 40/16	1600	300	350	350	40	1140	940	2260	12.5	3-phase	735
HFL 64/16	1600	400	400	400	64	1240	990	2310	18.5	3-phase	910
HFL 160/16	1600	500	550	550	160	1410	1240	2490	21.5	3-phase	1290
HFL 16/17	1700	200	300	260	16	1010	890	1990	12.5	3-phase ²	530
HFL 40/17	1700	300	350	350	40	1140	940	2260	12.5	3-phase	735
HFL 64/17	1700	400	400	400	64	1240	990	2310	18.5	3-phase	910
HFL 160/17	1700	500	550	550	160	1410	1240	2490	21.5	3-phase	1290

¹External dimensions vary when furnace is equipped with additional equipment. Dimensions on request.

²Heating only between two phases

*Please see page 84 for more information about supply voltage



Automatic gas supply system with solenoid valve and rotameter

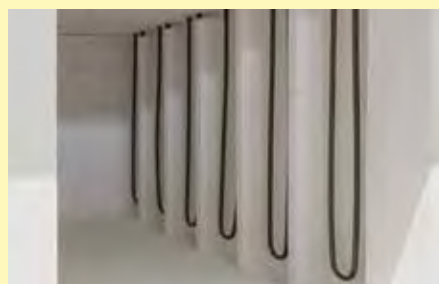

Protection of heating elements against mechanical damage during loading and unloading as additional equipment



Light-weight refractory bricks and heating elements made from molybdenum disilicide

Furnaces for Special Applications



Dual shell ventilated housing made of textured stainless steel sheets for low surface temperature and high stability



Exclusive use of insulation materials without categorization according to EC Regulation No 1272/2008 (CLP). This explicitly means that alumino silicate wool, also known as “refractory ceramic fiber” (RCF), which is classified and possibly carcinogenic, is not used.



NTLog Basic for Nabertherm controller: recording of process data with USB-flash drive



Defined application within the constraints of the operating instructions



As additional equipment: Process control and documentation via VCD software package for monitoring, documentation and control



Furnace Group	Model	Page
Fire assay/cupellation furnaces up to 1300 °C	N .. CUP	72
Gradient or lab strand annealing furnaces up to 1300 °C	GR	74
Fast-firing furnaces up to 1300 °C	LS	75
Laboratory melting furnaces up to 1400 °C	K, KC	76

Fire Assay/Cupellation Furnaces up to 1300 °C

Cupellation is a process to separate precious metals, such as gold or silver, from alloys with base metals. During the process, aggressive gases that attack the insulation and the heating are released. Cupellation furnaces N .. /13 CUP are especially designed for the very demanding process requirements.

The furnace chamber consists of a ceramic muffle, which offers very good protection for the heating elements and insulation against the vapors. A special fresh-air and exhaust air system guides exhaust gases directly into the exhaust hood of the cupellation furnace. At the same time, fresh air is lead into the furnace atmosphere. The integrated exhaust hood on top of the furnace and above the door is the interface to the customer's required exhaust air system. The design is very-maintenance friendly; all wear and tear parts on the furnace, which are f.i. the ceramic muffle and the heating elements, can be replaced easily.

Cupellation furnaces N 4/13 CUP as a tabletop model and N 10/13 CUP are designed especially for cupellation. Due of its high chamber design, model N 30/13 CUP can also be used for crucible melting. Pit-type furnace S 73/HS is especially designed for crucible melting.



Cupellation furnace N 4/13 CUP as a tabletop model

Standard Equipment of Cupellation Furnace N 4/13 CUP

- Compact tabletop model
- Ceramic muffle to protect the heating elements and insulation
- Furnace chamber is heated from three sides (floor and sides) with heating elements on support tubes
- Extraction system with integrated exhaust hood on top of the furnace and above the door to connect to the customer's exhaust air system
- Manual lift door

Additional Equipment for Cupellation Furnace N 4/13 CUP

- Over-temperature limiter with adjustable cutout temperature as temperature limiter to protect the furnace and load

Standard Equipment of Cupellation Furnaces N 10/13 CUP and N 30/13 CUP

- Ceramic muffle to protect the heating elements and insulation
- Furnace chamber is heated from 4 sides with heating elements on support tubes
- The heating elements can be easily replaced as one unit
- Furnace chamber ventilated as additional protection for the heating elements
- Precise temperature control with control thermocouple directly in the muffle
- Closing brick for the muffle with handle for N 10/13 CUP
- Electro-mechanic lift door for N 30/13 CUP
- Bench/surface in front of muffle
- Special fresh-air and exhaust air system for the ceramic muffle. Exhaust gases are directly guided into the exhaust hood via a ceramic tube at the back of the muffle. The air exchange rate is adjustable.
- Extraction system with integrated exhaust hood on top of the furnace and above the door to connect to the customer's exhaust air system
- Over-temperature limiter with adjustable cutout temperature as temperature limiter to protect the furnace and load



Cupellation furnace N 10/13 CUP with closing brick and base on castors



Compact heating element, easy to replace (cupellation furnaces N 10/13 CUP and N 30/13 CUP)

Additional Equipment for Cupellation Furnaces N 10/13 CUP and N 30/13 CUP

- Electro-mechanic lift door for N 10/13 CUP
- Swiveling inspection window as heat protection
- Timer to program switching on and off times (preset temperature)
- Base mounted on castors



Pit-type furnace S 73/HS with split lid

Standard Equipment of Pit-Type Furnace S 73/HS

- Compact pit-type furnace for crucible melting
- Split lid, opened manually by swiveling
- Heating from four sides
- Heating elements and floor protected against friction and aggressive substances with silicon carbide tiles
- Furnace chamber ventilated as additional protection for the heating elements
- Exhaust air box with insulated tube to the rear. Facilities for connection to customer's necessary extraction system.

Additional Equipment for Pit-Type Furnace S 73/HS

- Manual rolling lid
- Pneumatic rolling lid
- Over-temperature limiter with adjustable cutout temperature as temperature limiter to protect the furnace and load
- Timer to program switching on and off times (preset temperature)

Model	Tmax °C	Inner dimensions in mm			Volume in l	Outer dimensions ¹ in mm			Connected load kW	Electrical connection*	Weight in kg
		w	d	h		W	D	H			
N 4/13 CUP	1280	185	250	80	3.7	800	750	750	3	1-phase	105
N 10/13 CUP	1300	250	540	95	8.0	800	1300	1850	15	3-phase	450
N 30/13 CUP	1300	250	500	250	25.0	1050	1300	2150	15	3-phase	480
S 73/HS	1300	530	380	360	73.0	1050	1530	900	26	3-phase	890

¹External dimensions vary when furnace is equipped with additional equipment. Dimensions on request.

*Please see page 84 for more information about supply voltage



Pit-type furnace S 73/HS with rolling lid



Sides and floor lined with silicon carbide tiles as protection for pit-type furnace S 73/HS



N 10/13 CUP with optional electromotoric lift door

Gradient or Lab Strand Annealing Furnaces up to 1300 °C

The furnace chamber of the gradient furnace GR 1300/13 is divided in six control zones of equal length. The temperature in each of the six heating zones is separately controlled. The gradient furnace is usually charged from the side through the parallel swivel door. A maximum temperature gradient of 400 °C can then be stabilized over the heated length of 1300 mm. On request the furnace also is designed as a lab strand annealing furnace with a second door on the opposite side. If the included fiber separator are used charging is carried-out from the top.



Gradient furnace GR 1300/13S

Standard Equipment

- Tmax 1300 °C
- Heated length: 1300 mm
- Heating elements on support tubes providing for free heat radiation in the kiln chamber
- Charging from the top or through the right side door
- Gas damper suspension of the lid
- Separate control of heating zones (each 160 mm long)
- Temperature gradient of 400 °C over the entire length of the kiln chamber, each zone can individually be controlled
- Fiber separators dividing the chamber in six equally sized chambers
- Controller H1700, alternative controllers see page 84

Additional Equipment

- Up to ten control zones
- Second parallel swing door for use as lab strand annealing furnace
- Vertical instead of horizontal strand furnace
- 1400 °C model

Model	Tmax °C	Inner dimensions in mm			Outer dimensions ¹ in mm			Connected load kW	Electrical connection*	Weight in kg
		w	d	h	W	D	H			
GR 1300/13	1300	1300	100	60	1790	1020	1350	18	3-phase	400

¹External dimensions vary when furnace is equipped with additional equipment. Dimensions on request.

*Please see page 84 for more information about supply voltage



Parallel front swing door



Gradient furnace GR 1300/13S



Furnace chamber of gradient furnace GR 1300/13 with second door as additional equipment

Fast-Firing Furnaces up to 1300 °C

These fast-firing furnaces are ideal for simulation of typical fast-firing processes up to a maximum firing temperature of 1300 °C. The combination of high performance, low thermal mass and powerful cooling fans provides for cycle times from cold to cold up to 35 minutes with an opening temperature of approx. 300 °C.



Fast-firing furnace LS 25/13

Standard Equipment

- Tmax 1300 °C
- Ceramic grid tubes as charge support
- Floor and lid heating, two-zone control
- Special arrangement of the heating elements for optimum temperature uniformity
- Rapid switching cycles result in precise temperature control
- Integrated cooling fans, programmable to speed up charge cooling including housing cooling
- Programmable lid opening of approximately 60 mm for faster cooling without activating the fan
- Thermocouple type S for top and bottom zone
- Castors for easy furnace moving
- Controller with touch operation P570 (50 programs with each 40 segments), alternative controllers see page 84

Model	Tmax °C	Inner dimensions in mm			Volume in l	Outer dimensions ² in mm			Connected load kW	Electrical connection*	Weight in kg
		w	d	h		W	D	H			
LS 12/13	1300	350	350	40	12	750	880	1090	15	3-phase ¹	150
LS 25/13	1300	500	500	100	25	900	1030	1150	22	3-phase ¹	160

¹Heating only between two phases

²External dimensions vary when furnace is equipped with additional equipment. Dimensions on request.

*Please see page 84 for more information about supply voltage



Fast-firing furnace LS 25/13

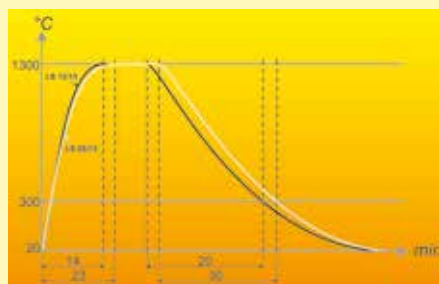

Firing curves of fast-firing furnaces LS 12/13 and LS 25/13



Floor and lid heating, two-zone control

Laboratory Melting Furnaces up to 1400 °C

These compact melting furnaces for the melting of non-ferrous metals and alloys are one of a kind and have a number of technical advantages. Designed as tabletop models, they can be used for many laboratory applications. The practical counter balanced hinge with shock absorbers and the spout (not for KC 4/14) on the front of the furnace make exact dosing easy when pouring the melt. The melting furnaces are available for furnace chamber temperatures of 1000 °C, 1300 °C, or 1400 °C.



Melting furnace KC 4/14

Standard Equipment

- Tmax 1000 °C, 1300 °C, or 1400 °C
- Crucible sizes of 0.75, 1.5 or 3 liters
- Crucible with integrated pouring spout of clay-graphite included with delivery
- Additional spout (not for KC 4/14), mounted at the furnace for exact pouring
- Compact bench-top design, simple emptying of crucible by tilting system with gas damper
- Crucible for heating up of melting furnace insulated with a hinged lid, lid opened when pouring
- Controller R7 (resp. 3508 for KC), alternative controllers see page 84

Additional Equipment

- Other crucible types available, e.g. steel
- Design as bale-out furnace without tilting device, e.g. for lead melting
- Over-temperature limiter for the furnace chamber with automatic reset to protect against overtemperature. The limit controller switches off the heating when the pre-set limit temperature has been reached and does not switch it on again until the temperature falls below the setting again.
- Observation hole for melt

Model	Tmax furnace °C	Tmax melt bath °C	Crucible	Capacity in kg		Volume in l	Outer dimensions ³ in mm			Connected load kW	Weight in kg
				Al	Cu		W	D	H		
K 1/10	1000	850	A6	1.5	-	0.75	600	710	670	3.0	85
K 2/10	1000	850	A10	3.0	-	1.50	600	710	670	3.0	90
K 4/10	1000	850	A25	7.0	-	3.00	670	800	710	3.5	110
K 1/13 ¹	1300	1150	A6	1.5	6.0	0.75	600	710	670	3.0	85
K 2/13 ¹	1300	1150	A10	3.0	10.0	1.50	600	710	670	3.0	90
K 4/13 ¹	1300	1150	A25	7.0	25.0	3.00	670	800	710	5.5	110
KC 1/14 ²	1400	1250	A6	-	6.0	0.75	570	630	580	11.0	90
KC 2/14 ²	1400	1250	A10	-	10.0	1.50	570	630	580	11.0	95
KC 4/14 ²	1400	1250	A25	-	25.0	3.00	670	870	590	22.0	110

¹Outer dimensions of furnace, transformer in separate housing (500 x 570 x 300 mm)

²Switchgear and controller mounted in a floor standing cabinet

³External dimensions vary when furnace is equipped with additional equipment. Dimensions on request.



Tilting-aid with dampers



Furnace K 4/10 with steel crucible, e.g. for tin melting



Melting furnace KC 1/14

Temperature Uniformity and System Accuracy

Temperature uniformity is defined as the maximum temperature deviation in the work space of the furnace. There is a general difference between the furnace chamber and the work space. The furnace chamber is the total volume available in the furnace. The work space is smaller than the furnace chamber and describes the volume which can be used for charging.



Holding frame for measurement of temperature uniformity

Specification of Temperature Uniformity in +/- K in the Standard Furnace

In the standard design the temperature uniformity is specified in +/- K at a defined set-temperature with the work space of the empty furnace during the dwell time. In order to make a temperature uniformity survey the furnace should be calibrated accordingly. As standard our furnaces are not calibrated upon delivery.

Calibration of the Temperature Uniformity in +/- K

If an absolute temperature uniformity at a reference temperature or at a defined reference temperature range is required, the furnace must be calibrated appropriately. If, for example, a temperature uniformity of +/- 5 K at a set temperature of 750 °C is required, it means that measured temperatures may range from a minimum of 745 °C to a maximum of 755 °C in the empty work space.

System Accuracy

Tolerances may occur not only in the work space, they also exist with respect to the thermocouple and in the controls. If an absolute temperature uniformity in +/- K at a defined set temperature or within a defined reference working temperature range is required, the following measures have to be taken:

- Measurement of total temperature deviation of the measurement line from the controls to the thermocouple
- Measurement of temperature uniformity within the work space at the reference temperature or within the reference temperature range
- If necessary, an offset is set at the controls to adjust the displayed temperature at the controller to the real temperature in the furnace
- Documentation of the measurement results in a protocol

Temperature Uniformity in the Work Space incl. Protocol

In standard furnaces, temperature uniformity is guaranteed as +/- K without measurement of temperature uniformity. However, as an additional feature, a temperature uniformity measurement at a target temperature in the work space compliant with DIN 17052-1 can be ordered. Depending on the furnace model, a holding frame which is equivalent in size to the work space is inserted into the furnace. This frame holds thermocouples at up to 11 defined measurement positions. The measurement of the temperature uniformity is performed at a target temperature specified by the customer after a static condition has been reached. If necessary, different target temperatures or a defined target working temperature range can also be calibrated.



Pluggable frame for measurement for forced convection chamber furnace N 7920/45 HAS

The system accuracy is defined by adding the tolerances of the controls, the thermocouple and the work space

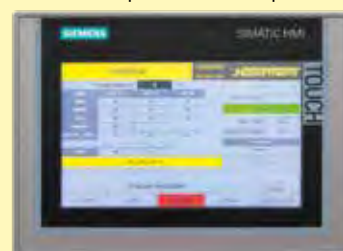

Precision of the controls, e. g. +/- 1 K

Deviation of thermocouple, e. g. +/- 1.5 K

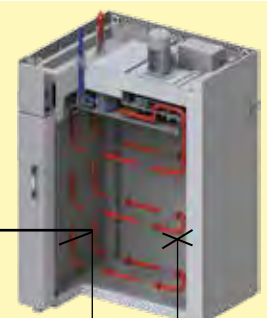

Deviation from measuring point to the average temperature in the work space e. g. +/- 3 K

Process Control and Documentation





	Page
Nabertherm controller series 500	80
MyNabertherm app for mobile monitoring of process progress	82
Functions of the standard controllers	84
Process data storage and data input via PC	85
PLC controls - HiProSystems	87
Process data storage	88
Nabertherm control center NCC	89

Nabertherm Controller Series 500

**I AM THE
CONTROLLER**

I'm the big brother of analog buttons and turning switches. I am the new generation of control and intuitive operation. My skills are highly complex, my operation is simple. I can be touched and speak 24 languages. I'll show you exactly which program is currently running and when it ends.



The controller series 500 impresses with its unique scope of performance and intuitive operation. In combination with the free "MyNabertherm" smartphone app, the monitoring of the furnace is even easier and more powerful than ever before. The operation and programming takes place via a high-contrast, large touch panel, which shows exactly the information that is relevant at the moment.



B510, C550, P580



B500, C540, P570

Standard Equipment

- Transparent, graphic display of the temperature curves
- Clear presentation of the process data
- 24 operating languages selectable
- Consistent, attractive design
- Easily understandable symbols for many functions
- Precise and accurate temperature control
- User levels
- Program status display with estimated end time and date
- Documentation of the process curves on USB storage medium in .csv file format
- Service information can be read out via USB stick
- Clear presentation
- Plain text display
- Configurable for all furnace families
- Can be parameterized for the different processes



Highlights

In addition to the well-known and matured controller functions, the new generation offers you some individual highlights. Here is an overview of the most important ones for you:

Modern Design

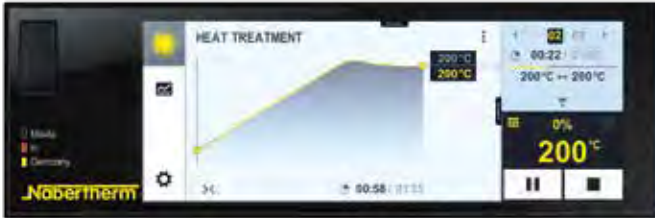

Colored display of temperature curves and process data

Easy Programming



Simple and intuitive program entry via touch panel

Integrated Help Function

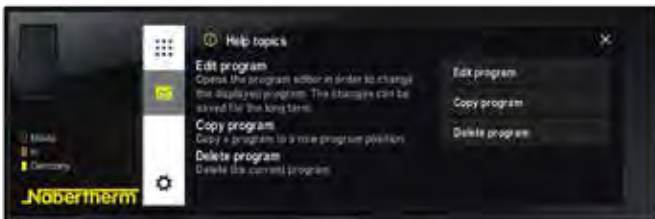

Information on various commands in plain text

Program Management



Temperature programs can be saved as favorites and in categories

Segment Player



Detailed overview of process information including setpoint, actual value and switched functions

Wi-Fi-Capable



Connection with the MyNabertherm app



Intuitive touch screen



Easy program entry and control



Precise temperature control



User levels



Process documentation on USB

Further information on Nabertherm controllers, process documentation and tutorials on operation can be found on our website: <https://nabertherm.com/en/series-500>



MyNabertherm App for Mobile Monitoring of Process Progress

MyNabertherm app – the powerful and free digital accessory for Nabertherm 500 Series Controllers. Use the app for convenient online progress monitoring of your Nabertherm furnaces – from your office, while on the way or from wherever you wish. The app always keeps you in the picture. Just like the controller itself, the app is also available in 24 languages.



Convenient monitoring of one or multiple Nabertherm furnaces simultaneously



Display of program progress for each furnace



Easy to contact

App-Functions

- Convenient monitoring of one or multiple Nabertherm furnaces simultaneously
- Clear presentation as a dashboard
- Individual overview of a furnace
- Display of active/inactive furnaces
- Operating status
- Current process data

Display of Program Progress for Each Furnace

- Graphical representation of the program progress
- Display of furnace name, program name, segment information
- Display of start time, program run time, remaining run time
- Display of additional functions such as fresh-air fan, exhaust air flap, gassing, etc.
- Operating modes as symbol

Push Notifications in Case of Malfunctions and at Program End

- Push notification on the lock screen
- Display of malfunctions with an associated description in the individual overview and in a message list

Contact with Service Possible

- Stored furnace data facilitate rapid support for you

Requirements

- Connection of the furnace to the Internet via the customer's Wi-Fi
- For mobile devices with Android (from version 9) or IOS (from version 13)



Monitoring of Nabertherm furnaces with 500 series touch panel controller for Arts & Crafts, laboratory, dental, thermal process technology, advanced materials and foundry applications.

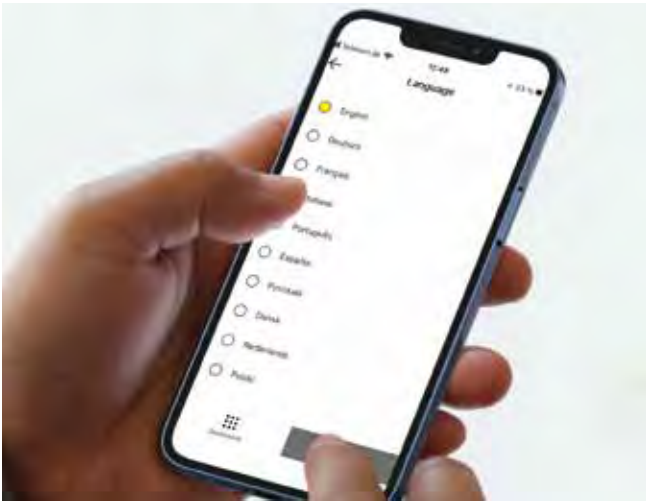

Available in 24 languages



Push notifications in case of malfunctions



Clear contextual menu

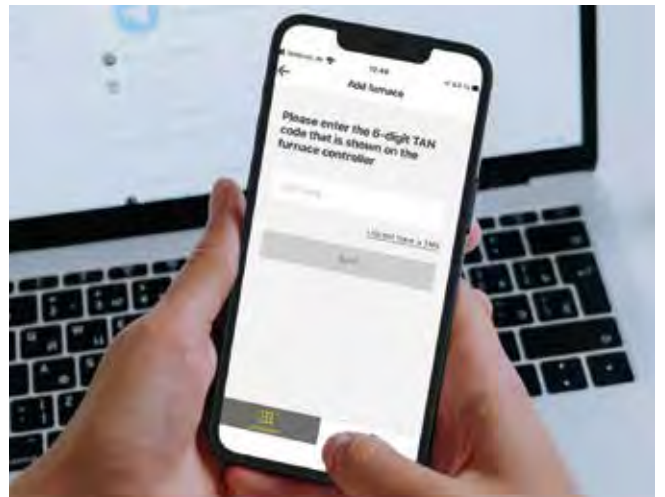

Any addition of Nabertherm furnaces

Everything on display in the new Nabertherm app for the new controller series 500. Get the most out of your furnace with our app for iOS and Android. Don't hesitate to download it now.

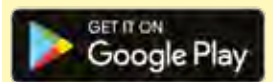

Functions of the Standard Controllers

	R7	3216	3208	B500/ B510	C540/ C550	P570/ P580	D580 ⁴	3504	H500	H1700	H3700	NCC
Number of programs	1	1	1	5	10	50	> 50	25	20	20	20	100
Segments	1	8	1	4	20	40	7	500 ³	20	20	20	20
Extra functions (e. g. fan or autom. flaps) maximum				2	2	2-6		2-8 ³	3 ³	6/2 ³	8/2 ³	16/4 ³
Maximum number of control zones	1	1	1	1	1	3	1	2 ^{1,2}	1-3 ³	8	8	8
Drive of manual zone regulation				●	●	●		○	○	○	○	○
Charge control/bath control								○	○	○	○	○
Auto tune		●	●	●	●	●		●				
Real-time clock				●	●	●	●		●	●	●	●
Graphic color display				●	●	●	●		4" 7"	7"	12"	22"
Graphic display of temperature curves (program sequence)							●					
Status messages in clear text			●	●	●	●	●	●	●	●	●	●
Data entry via touchpanel				●	●	●	●	●	●	●	●	●
Entering program names (i.e. "Sintering")				●	●	●	●			●	●	●
Keypad lock				●	●	●	●	●				
User levels				●	●	●	●		○	○	○	●
Skip-button for segment jump				●	●	●	●		●	●	●	●
Program entry in steps of 1 °C or 1 min.	●	●	●	●	●	●	1 sec.	●	●	●	●	●
Start time configurable (e. g. to use night power rates)				●	●	●	●	●	●	●	●	●
Switch-over °C/°F	○	○	○	●	●	●	●	○	●	● ³	● ³	● ³
kWh meter				●	●	●	●					
Operating hour counter				●	●	●	●		●	●	●	●
Set point output			○	●	●	●		○		○	○	○
NTLog Comfort for HiProSystems: recording of process data on an external storage medium				●	●	●	●		○	○	○	
NTLog Basic for Nabertherm controller: recording of process data with USB-flash drive				○	○	○	●					
Interface for VCD software				●	●	●	●		●	●	●	●
Malfunction memory				●	●	●	●		●	●	●	●
Number of selectable languages				24	24	24	24					
Wi-Fi-capable („MyNabertherm“ app)				●	●	●	●					

¹Not for melt bath control

²Control of additional separate slave regulators possible

³Depending on the design

⁴Controls description for D580 see chapter „Firing furnace and pressing furnace“ in catalog „Dental Furnaces“

● Standard

○ Option

Which controller for which furnaces	L 1/12	L 3 - LT 60	LE	L(T) 9/11/SKM	LV(T)	L .. BO	L(T) .. SW	RD	R	RSH	RSV	RSRB	RSRC	RT	RHTC	RHTH/RHTV	TR	KTR	NAT	NA	TR .. LS	NA .. LS	LH, LF	N .. H	LHT .. (D)	LHTC(T)	LHT .. LB Speed	LHT .. SW	LHT .. BO	HT, HTC, HFL	N .. CUP	GR	LS	K	KC		
Catalog page	6	6,9,10	8	11	12	14	15	20	20	22	22	24	26	28	29	30	42	44	46	48	50	51	54	56	60	62	63	64	65	66-69	72	74	75	76	76		
Controller																																					
R7	●		●					●									●																		●		
3508												●	●							●																	●
B500																		●	● ³		●		●	●													
B510	●			●	●		●		●	●		●		●		○			● ³		●																
C540												○	○					○	○ ³	○			○	○													
C550	○			○	○	●	○		○	○		○	○	○				○	○ ³		○				●												
P570																●			○ ³			●	○	○				●									
P580	○			○	○	○	○		○	○		○	○	○	●	○			○ ³		○		○		●		●										
H500/PLC																○							○						● ³								
H1700/PLC																		○											○								
H3700/PLC																		○											○								
NCC																○		○											○								

Mains Voltages for Nabertherm Furnaces

1-phase: all furnaces are available for mains voltages from 110 V - 240 V at 50 or 60 Hz.

3-phase: all furnaces are available for mains voltages from 200 V - 240 V or 380 V - 480 V, at 50 or 60 Hz.

Process Data Storage and Data Input via PC



There are various options for evaluation and data input the processes for optimal process documentation and data storage. The following options are suitable for data storage when using the standard controllers.

Data Storing of Nabertherm Controllers with NTLog Basic

NTLog Basic allows for recording of process data of the connected Nabertherm Controller (B500, B510, C540, C550, P570, P580) on a USB stick. The process documentation with NTLog Basic requires no additional thermocouples or sensors. Only data recorded which are available in the controller. The data stored on the USB stick (up to 130,000 data records, format CSV) can afterwards be evaluated on the PC either via NTGraph or a spreadsheet software used by the customer (e.g. Excel™ for MS Windows™). For protection against accidental data manipulation the generated data records contain checksums.

Visualization with NTGraph for MS Windows™ for Single-Zone Controlled Furnaces

The process data from NTLog can be visualized either using the customer's own spreadsheet program (e.g. Excel™ for MS Windows™) or NTGraph for MS Windows™ (Freeware). With NTGraph Nabertherm provides for an additional user-friendly tool free of charge for the visualization of the data generated by NTLog. Prerequisite for its use is the installation of the program Excel™ for MS Windows™ (from version 2003). After data import presentation as diagram, table or report can be chosen. The design (color, scaling, reference labels) can be adapted by using prepared sets. NTGraph is available in eight languages (DE/EN/FR/ES/IT/CN/RU/PT). In addition, selected texts can be generated in other languages.

Software NTEdit for MS Windows™ for Entering Programs on the PC

By using the software NTEdit for MS Windows™ (Freeware) the input of the programs becomes clearer and thus easier. The program can be entered on customers PC and then be imported into the controller (B500, B510, C540, C550, P570, P580) with a USB stick. The display of the set curve is tabular or graphical. The program import in NTEdit is also possible. With NTEdit Nabertherm provides a user-friendly free tool. A prerequisite for the use is the client installation of Excel™ for MS Windows™ (from version 2007). NTEdit is available in eight languages (DE/EN/FR/ES/IT/CN/RU/PT).



NTGraph, a freeware for the easy-to-read analysis of recorded data using Excel™ for MS Windows™



Recording of process data of the connected controller via USB stick



Process input via the NTEdit software (freeware) for MS Windows™

Process Data Storage

VCD-software for visualization, control and documentation

Documentation and reproducibility are more and more important for quality assurance. The powerful VCD software represents an optimal solution for single multi furnace systems as well as charge documentation on the basis of Nabertherm controllers.

The VCD software is used to record process data of the series 500 and series 400 as well as various further Nabertherm controllers. Up to 400 different heat treatment programs can be stored. The controllers are started and stopped via the software at a PC. The process is documented and archived accordingly. The data display can be carried-out in a diagram or as data table. Even a transfer of process data to Excel™ for MS Windows™ (.csv format *) or the generation of reports in PDF format is possible.



Example lay-out with 3 furnaces

Features

- Available for controllers series 500 - B500/B510/C540/C550/P570/P580, series 400 - B400/B410/C440/C450/P470/P480, Eurotherm 3504 and various further Nabertherm controllers
- Suitable for operating systems Microsoft Windows 7/8/10/11
- Simple installation
- Setting, Archiving and print of programs and graphics
- Operation of controllers via PC
- Archiving of process curves from up to 16 furnaces (also multi-zone controlled)
- Redundant saving of archives on a server drive
- Higher security level due to binary data storage
- Free input of charge date with comfortable search function
- Possibility to evaluate data, files exportable to Excel™ for MS Windows™
- Generation of a PDF-report
- 24 languages selectable

Extension Package 1 for display of an additional temperature measuring point, independent of the furnace controls

- Connection of an independent thermocouple, type S, N or K with temperature display on a supplied C6D display, e. g. for documentation of charge temperature
- Conversion and transmission of measured values to the VCD software
- For data evaluation, please see VCD-software features
- Display of measured temperature directly on the extension package

Extension Package 2 for the connection of up to three, six or nine measuring point, independent of the furnace controls

- Connection of three thermocouples, type K, S, N or B to the included connecting box
- Possible extension of up to two or three connecting boxes with up to nine measuring points
- Conversion and transmission of measured values to the VCD software
- Data evaluation, see VCD features



VCD Software for Control, Visualisation and Documentation



Graphic display of main overview (version with 4 furnaces)

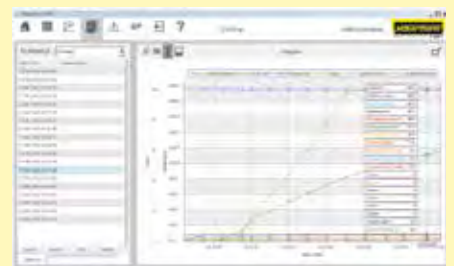

Graphic display of process curve

PLC Controls HiProSystems



This professional process control with PLC controls for single and multi-zone furnaces is based on Siemens hardware and can be adapted and upgraded extensively. HiProSystems control is used when process-dependent functions, such as exhaust air flaps, cooling fans, automatic movements, etc., have to be handled during a cycle, when furnaces with more than one zone have to be controlled, when special documentation of each batch is required and when remote service is required. It is flexible and is easily tailored to your process or documentation needs.

Alternative User Interfaces for HiProSystems

Process Control H500

This basic panel accommodates most basic needs and is very easy to use. Firing cycle data and the extra functions activated are clearly displayed in a table. Messages appear as text. Data can be stored on a USB stick using the „NTLog Comfort“ option.

Process Control H1700

Customized versions can be realized in addition to the scope of services of the H500. Display of basic data as online trend on a color 7" display with graphically structured interface.

Process Control H3700

Display of functions on a large 12" display. Display of basic data as online trend or as a graphical system overview. Scope as H1700.

Remote Maintenance Router – Fast Support in Case of a Malfunction

For fast failure diagnosis in case of a malfunction, remote maintenance systems are used for HiProSystems-plants (depending on the model). The plants are equipped with a router, which will be connected to the internet by the customer. In case of a malfunction, Nabertherm is able to get access to the furnace controls via a secured connection (VPN tunnel) and to perform a malfunction diagnosis. In most cases, the problem can be directly solved by a technician on site according with supervision from Nabertherm.

If no Internet connection can be provided, we offer optionally the remote maintenance via LTE network as additional equipment.



H1700 with colored, tabular depiction



H3700 with colored graphic presentation



Router for remote maintenance

Process Data Storage



The following options are available for industrial process documentation and the recording of data from several furnaces. These can be used to document the process data for the PLC controls.



NTLog Comfort for data recording of a Siemens PLC via USB stick

Data Storing of HiProSystems with NTLog Comfort

The extension module NTLog Comfort offers the same functionality of NTLog Basic module. Process data from a HiProSystems control are read out and stored in real time on a USB stick. The extension module NTLog Comfort can also be connected using an Ethernet connection to a computer in the same local network so that data can be written directly onto this computer.

Temperature Recorder

Besides the documentation via the software which is connected to the controls, Nabertherm offers different temperature recorders which can be used with respect to the application.

	Model 6100e	Model 6100a	Model 6180a
Data input using touch panel	x	x	x
Size of colour display in inch	5.5"	5.5"	12.1"
Number of thermocouple inputs	3	18	48
Data read-out via USB-stick	x	x	x
Input of charge data		x	x
Evaluation software included	x	x	x
Applicable for TUS-measurements acc. to AMS2750G			x

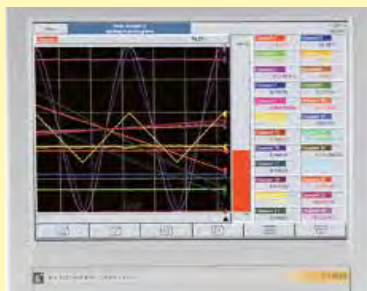

Temperature recorder

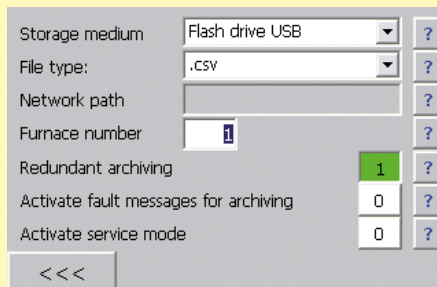

NTLog Comfort - Data recording via USB stick

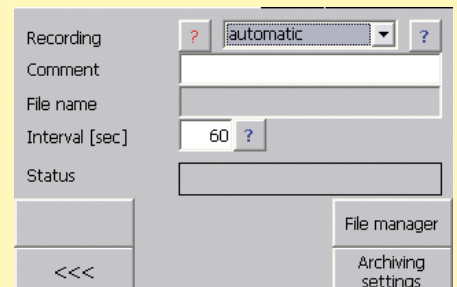

NTLog Comfort - Data recording online on the PC

Nabertherm Control Center NCC

PC-based control, process visualization and process documentation software

With the Nabertherm Control Center, a PC-based control system is offered as an ideal extension for furnaces with PLC-based HiProSystem control systems. The system has proven itself in many applications with increased demands on documentation and process reliability and also for convenient multi-furnace management. Many customers from the automotive, aviation, medical technology or technical ceramics sectors are working successfully with this powerful software.



Retort furnace NR 300/08 for treatment in high vacuum with NCC in separate cabinet

Basic Equipment

- Central operator interface in modern design
- Overview and central operation for up to 8 furnaces
- Convenient program management with 100 programs
- Simple, intuitive operation of the PC user interface
- Access management with 3 user levels and as many users as required
- Charge data input for each furnace operation
- Start times can be specified in order to pre-plan heat treatment cycles
- Tamper-proof, encrypted storage of charge documentation
- Live view of current furnace operations
- Archive with overview of performed cycles
- Search function for charge data and temperature curves of performed cycles
- Report function to assess the process as PDF or printout
- Delivery includes PC, monitor and printer



Retort furnace NR 80/11 with IDB safety concept for debinding in non-flammable protective gases with NCC in a separate cabinet

Extension Options

- Enter charge data via barcode
- Simple data recording, ideal for changing charges
- Ensure data quality with defined charge data
- Compare charge and program to increase process reliability
- Access rights via employee cards
- Software extension with documentation according to the requirements of the Food and Drug Administration (FDA), Part 11, EGV 1642/03
- Interface to connect higher level systems (OPC-UA), SQL connection, redundant data storage
- Control from different PC workstations
- Available as panel PC or virtual machine
- PC cabinet with UPS for PC
- Further customization possible on request

You will find more information about the Nabertherm Control Center with tutorial and click dummy on our website: [NCC | Nabertherm](https://nabertherm.com/de/ncc)

<https://nabertherm.com/de/ncc>

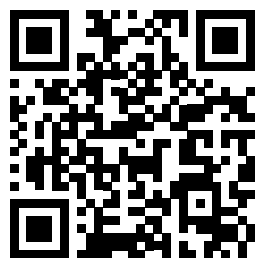



Spare Parts and Customer Service — Our Service Makes the Difference

For many years the name **Nabertherm** has been standing for top quality and durability in furnace manufacturing. To secure this position for the future as well, Nabertherm offers not only a first-class spare parts service, but also excellent customer service for our customers. Benefit from more than 75 years of experience in furnace construction.

In addition to our highly qualified service technicians on site, our service specialists in Lilienthal are also available to answer your questions about your furnace. We take care of your service needs to keep your furnace always up and running. In addition to spare parts and repairs, maintenance and safety checks as well as temperature uniformity measurements are part of our service portfolio. Our range of services also includes the modernization of older furnace systems or new linings.

The needs of our customers always have highest priority!



- Very fast spare parts supply, many standard spare parts in stock
- Worldwide customer service on site with its own service points in the largest markets
- International service network with long-term partners
- Highly qualified customer service team for quick and reliable repair of your furnace
- Commissioning of complex furnace systems
- Customer training in function and operation of the system
- Temperature uniformity measurements, also according to standards like AMS2750G (NADCAP)
- Competent service team for fast help on the phone
- Safe teleservice for systems with PLC controls via a secured VPN line
- Preventive maintenance to ensure that your furnace is ready for use
- Modernization or relining of older furnace systems

Contact us:

Spare parts



spares@nabertherm.de



+49 (4298) 922-0

Customer service



service@nabertherm.de



+49 (4298) 922-333



The whole World of Nabertherm: www.nabertherm.com

Please visit our website www.nabertherm.com and find out all you want to know about us - and especially about our products.

In addition to current information and exhibition dates, there is of course the possibility of direct contact or an authorized dealer from our worldwide dealer network.

Professional Solutions for:

- Thermal Process Technology
- Additive Manufacturing
- Advanced Materials
- Fiber Optics/Glass
- Foundry
- Laboratory
- Dental
- Arts & Crafts

Headquarters

Nabertherm GmbH

Bahnhofstr. 20
28865 Lilienthal, Germany
Tel +49 4298 922 0
contact@nabertherm.de

Sales Organisation

China

Nabertherm Ltd. (Shanghai)
No. 158, Lane 150, Pingbei Road, Minhang District
201109 Shanghai, China
Tel +86 21 64902960
contact@nabertherm-cn.com

France

Nabertherm SARL
20, Rue du Cap Vert
21800 Quetigny, France
Tel +33 6 08318554
contact@nabertherm.fr

Great Britain

Nabertherm Ltd., United Kingdom
Tel +44 7508 015919
contact@nabertherm.com

Italy

Nabertherm Italia
via Trento N° 17
50139 Florence, Italy
Tel +39 348 3820278
contact@nabertherm.it

Switzerland

Nabertherm Schweiz AG
Altgraben 31 Nord
4624 Härkingen, Switzerland
Tel +41 62 209 6070
contact@nabertherm.ch

Benelux

Nabertherm Benelux, The Netherlands
Tel +31 6 284 00080
contact@nabertherm.com

Spain

Nabertherm España
c/Marti i Julià, 8 Bajos 7ª
08940 Cornellà de Llobregat, Spain
Tel +34 93 4744716
contact@nabertherm.es

USA

Nabertherm Inc.
64 Reads Way
New Castle, DE 19720, USA
Tel +1 302 322 3665
contact@nabertherm.com



All other Countries: Follow
nabertherm.com/contacts